

# MultiLab 4010-3W

DIGITAL METER FOR (WIRELESS) IDS SENSORS



a xylem brand



For the most recent version of the manual, please visit [www.ysi.com](http://www.ysi.com).

**Contact** YSI  
1725 Brannum Lane  
Yellow Springs, OH 45387 USA  
Tel: +1 937-767-7241  
800-765-4974  
Email: [info@ysi.com](mailto:info@ysi.com)  
Internet: [www.ysi.com](http://www.ysi.com)

**Copyright** © 2018 Xylem Inc.

# Contents

<b>1</b>	<b>Overview</b>	<b>7</b>
1.1	MultiLab 4010-3W	7
1.2	Sensors	7
1.2.1	IDS sensors	7
1.2.2	Wireless operation of IDS sensors	8
1.2.3	IDS adapter for analog sensors	8
1.2.4	Automatic sensor recognition	9
<b>2</b>	<b>Safety</b>	<b>10</b>
2.1	Safety information	10
2.1.1	Safety information in the operating manual	10
2.1.2	Safety signs on the meter	10
2.1.3	Further documents providing safety information	10
2.2	Safe operation	10
2.2.1	Authorized use	10
2.2.2	Requirements for safe operation	11
2.2.3	Unauthorized use	11
<b>3</b>	<b>Commissioning</b>	<b>12</b>
3.1	Scope of delivery	12
3.2	Power supply	12
3.3	Initial commissioning	12
3.3.1	Connecting the power pack	13
<b>4</b>	<b>Operation</b>	<b>14</b>
4.1	General operating principles	14
4.1.1	Keypad	14
4.1.2	Display	15
4.1.3	Status information	15
4.1.4	Connectors	16
4.1.5	Channel display	17
4.1.6	Sensor info	17
4.1.7	Display of several sensors in the measuring mode	18
4.2	Switching on the meter	19
4.3	Switching off the meter	19
4.4	Navigation	19
4.4.1	Operating modes	19
4.4.2	Measured value display	19
4.4.3	Menus and dialogs	20
4.4.4	Navigation example 1: Setting the language	21
4.4.5	Example 2 on navigation: Setting the date and time	23

<b>5</b>	<b>pH value</b>	<b>25</b>
5.1	Measuring	25
5.1.1	Measuring the pH value	25
5.1.2	Measuring the temperature	27
5.2	pH calibration	27
5.2.1	Why calibrate?	27
5.2.2	When do you have to calibrate?	28
5.2.3	Calibration procedure	28
5.2.4	Carrying out automatic calibration (AutoCal)	28
5.2.5	Carrying out a manual calibration (ConCal)	31
5.2.6	Calibration points	34
5.2.7	Calibration data	35
5.2.8	Continuous measurement control (CMC function)	37
5.2.9	QSC function (sensor quality control)	39
<b>6</b>	<b>ORP</b>	<b>42</b>
6.1	Measuring	42
6.1.1	Measuring the ORP	42
6.1.2	Measuring the relative ORP	44
6.1.3	Measuring the temperature	45
6.2	ORP calibration	45
<b>7</b>	<b>Ion concentration</b>	<b>46</b>
7.1	Measuring	46
7.1.1	Measuring the ion concentration	46
7.1.2	Measuring the temperature	48
7.2	Calibration	50
7.2.1	Why calibrate?	50
7.2.2	When to calibrate?	50
7.2.3	Calibration (ISE Cal)	50
7.2.4	Calibration standards	53
7.2.5	Calibration data	54
7.3	Selecting the measuring method	56
7.3.1	<i>Standard addition</i>	57
7.3.2	<i>Standard subtraction</i>	59
7.3.3	<i>Sample addition</i>	61
7.3.4	<i>Sample subtraction</i>	63
7.3.5	Standard addition with blank value correction ( <i>Blank value addition</i> )	66
<b>8</b>	<b>Dissolved oxygen</b>	<b>68</b>
8.1	Measuring	68
8.1.1	Measuring D.O.	68
8.1.2	Measuring the temperature	70
8.2	FDO Check (checking the FDO 4410)	71
8.2.1	Why should you check the sensor?	71
8.2.2	When should you check the sensor?	71
8.2.3	Perform a FDO Check	71
8.2.4	Evaluation	72
8.3	Calibration	73
8.3.1	Why calibrate?	73
8.3.2	When to calibrate?	73

8.3.3	Calibration procedures . . . . .	73
8.3.4	Calibration in water vapor-saturated air . . . . .	73
8.3.5	Calibrating with <i>Comparison meas.</i> (e.g. Winkler titration) . . . . .	74
8.3.6	<i>Zero Calibration</i> . . . . .	76
8.3.7	Calibration data . . . . .	77
8.4	Measuring with methods . . . . .	79
8.4.1	General information . . . . .	79
8.4.2	Selecting and starting the measuring method . . . . .	80
8.4.3	Editing the setting for the measuring method . . . . .	81
8.4.4	<i>OUR</i> (Oxygen Uptake Rate) . . . . .	82
8.4.5	<i>SOUR</i> (Specific Oxygen Uptake Rate) . . . . .	84
8.4.6	Measurement data storage for <i>OUR/SOUR</i> measurements . . . . .	87
<b>9</b>	<b>Conductivity . . . . .</b>	<b>89</b>
9.1	Measuring . . . . .	89
9.1.1	Measuring the conductivity . . . . .	89
9.1.2	Measuring the temperature . . . . .	91
9.2	Temperature compensation . . . . .	91
9.3	Calibration . . . . .	92
9.3.1	Why calibrate? . . . . .	92
9.3.2	When to calibrate? . . . . .	92
9.3.3	Calibration procedure . . . . .	92
9.3.4	Determining the cell constant (calibration in the check- and calibration standard) . . . . .	93
9.3.5	Setting the cell constant (calibration with freely selectable check- and calibration standard) . . . . .	94
9.3.6	Calibration data . . . . .	95
<b>10</b>	<b>Settings . . . . .</b>	<b>97</b>
10.1	pH measurement settings . . . . .	97
10.1.1	Settings for pH measurements . . . . .	97
10.1.2	Buffer sets for calibration . . . . .	99
10.1.3	Calibration interval . . . . .	101
10.2	ORP measurement settings . . . . .	102
10.3	ISE measurement settings . . . . .	102
10.4	D.O. measurement settings . . . . .	104
10.4.1	Settings for D.O. measurement . . . . .	104
10.4.2	Enter <i>Sensor cap coefficients</i> (ProOBOD) . . . . .	106
10.4.3	<i>DO % Saturation local</i> . . . . .	106
10.5	Cond measurement settings . . . . .	106
10.5.1	Settings for IDS conductivity sensors . . . . .	106
10.6	Sensor-independent settings . . . . .	109
10.6.1	<i>System</i> . . . . .	109
10.6.2	<i>Data storage</i> . . . . .	110
10.6.3	<i>Automatic Stability control</i> . . . . .	110
10.7	Reset . . . . .	111
10.7.1	Resetting the measurement settings . . . . .	111
10.7.2	Resetting the system settings . . . . .	113
<b>11</b>	<b>Data storage . . . . .</b>	<b>114</b>
11.1	Manual storage . . . . .	114
11.2	Automatic data storage at intervals . . . . .	114
11.3	Measurement data storage . . . . .	117

---

11.3.1	Managing the measurement data storage	117
11.3.2	Erasing the measurement data storage	118
11.3.3	Measurement dataset	118
11.3.4	Storage locations	119
<b>12</b>	<b>Transmitting data</b>	<b>120</b>
12.1	Saving data to a USB memory device	120
12.2	Transmitting data to a USB printer	121
12.3	Transmitting data to a PC	122
12.4	MultiLab Importer	124
12.5	BOD Analyst Pro	125
<b>13</b>	<b>Maintenance, cleaning, disposal</b>	<b>126</b>
13.1	Maintenance	126
13.1.1	General maintenance activities	126
13.1.2	Exchanging the battery	126
13.2	Cleaning	127
13.3	Packing	127
13.4	Disposal	127
<b>14</b>	<b>What to do if....</b>	<b>128</b>
14.1	pH	128
14.2	ISE	130
14.3	Dissolved oxygen	131
14.4	Conductivity	132
14.5	General topics	132
<b>15</b>	<b>Technical data</b>	<b>135</b>
15.1	Measuring ranges, resolution, accuracy	135
15.2	General data	135
<b>16</b>	<b>Firmware update</b>	<b>139</b>
16.1	Firmware update for the meter MultiLab 4010-3W	139
16.2	Firmware-Update for IDS Sensors	140
<b>17</b>	<b>Glossary</b>	<b>141</b>
<b>18</b>	<b>Index</b>	<b>145</b>
<b>19</b>	<b>Appendix</b>	<b>147</b>
19.1	Oxygen solubility table	147
19.2	Calibration values for different barometric pressures and heights	149
19.3	Calculate the TDS Multiplier	150
<b>20</b>	<b>Contact Information</b>	<b>151</b>
20.1	Ordering & Technical Support	151
20.2	Service Information	151

# 1 Overview

## 1.1 MultiLab 4010-3W

The MultiLab 4010-3W meter enables you to perform measurements (pH, U, ISE, conductivity, and dissolved oxygen) quickly and reliably.

The MultiLab 4010-3W provides the maximum degree of operating comfort, reliability and measuring certainty for all applications.

The MultiLab 4010-3W supports you in your work with the following functions:

- proven calibration procedures
- automatic stability control (AR)
- automatic sensor recognition
- CMC (continuous measurement control)
- QSC (sensor quality control).

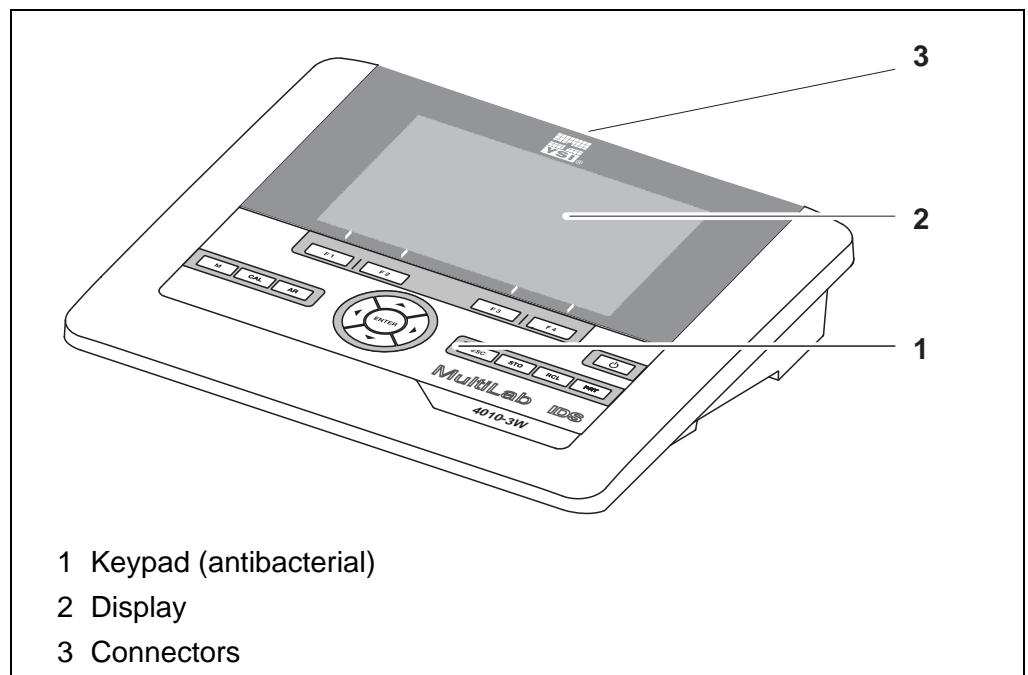

Due to its antibacterial properties, the keypad of the MultiLab 4010-3W is especially suitable for applications in an environment where hygiene is important (see SECTION 15.2 GENERAL DATA, page 135).

## 1.2 Sensors

### 1.2.1 IDS sensors

IDS sensors

- support the automatic sensor recognition
- show only the settings relevant to the specific sensor in the setting menu
- process signals in the sensor digitally so that precise and interference-free

measurements are enabled even with long cables

- facilitate to assign a sensor to a measured parameter with differently colored couplings
- have quick-lock couplings with which to fix the sensors to the meter.

### Sensor data from IDS sensors

IDS sensors transmit the following sensor data to the meter:

- SENSOR ID
  - Sensor name
  - Sensor serial number
- Calibration data
- Measurement settings

The calibration data are updated in the IDS sensor after each calibration procedure. A message is displayed while the data are being updated in the sensor.



In the measured value display, you can display the sensor name and serial number of the selected sensor with the [**i**] softkey. You can then display further sensor data stored in the sensor with the [More] softkey (see section 4.1.6 SENSOR INFO, page 17).

### 1.2.2 Wireless operation of IDS sensors

With the aid of the adapters in the IDS WA Kit, IDS sensors with plug head connectors (variant W) can be wirelessly connected to your MultiLab 4010-3W.

Two adapters, one at the IDS meter (IDS WA-M) and one at the sensor (IDS WA-S), replace the sensor cable with an energy-saving Bluetooth LE radio connection.



Further information on the wireless operation of IDS sensors:

- Web resources
- Operating manual of the IDS WA Kit.

### 1.2.3 IDS adapter for analog sensors

With the aid of an IDS adapter, you can also operate analog sensors on the MultiLab 4010-3W. The combination of the IDS adapter and analog sensor behaves like an IDS sensor.

The YSI 4011 adapter can be used to connect a YSI 5010 BOD probe (any variation) to a IDS sensor port on the MultiLab 4010-3W instrument.

### Installation shaft for IDS adapter

The MultiLab 4010-3W has a recess into which the IDS adapter (4010-2/3 pH Adapter DIN or 4010-2/3 pH Adapter BNC) available as an accessory can be permanently mounted.

In the MultiLab 4010-3W, the IDS adapter replaces a digital input (channel 2) with a socket for an analog pH sensor (DIN or BNC plug) and a temperature sensor.





Information on available IDS adapters is given on the Internet. Detailed information on the IDS adapter is given in the operating manual of the adapter.

#### 1.2.4 Automatic sensor recognition

The automatic sensor recognition for IDS sensors allows

- to operate an IDS sensor with different meters without recalibrating
- to operate different IDS sensors at one meter without recalibration
- to assign measurement data to an IDS sensor
  - Measurement datasets are always stored and output with the sensor name and sensor serial number.
- to assign calibration data to an IDS sensor
  - Calibration data and calibration history are always stored and output with the sensor name and sensor serial number.
- to activate the correct cell constant for conductivity sensors automatically
- to hide menus automatically that do not concern this sensor

To be able to use the automatic sensor recognition, a meter that supports the automatic sensor recognition (e.g. MultiLab 4010-3W) and a digital IDS sensor are required.

In digital IDS sensors, sensor data are stored that clearly identify the sensor. The sensor data are automatically taken over by the meter.

## 2 Safety

### 2.1 Safety information

#### 2.1.1 Safety information in the operating manual

This operating manual provides important information on the safe operation of the meter. Read this operating manual thoroughly and make yourself familiar with the meter before putting it into operation or working with it. The operating manual must be kept in the vicinity of the meter so you can always find the information you need.

Important safety instructions are highlighted in this operating manual. They are indicated by the warning symbol (triangle) in the left column. The signal word (e.g. "CAUTION") indicates the level of danger:



#### **WARNING**

indicates a possibly dangerous situation that can lead to serious (irreversible) injury or death if the safety instruction is not followed.



#### **CAUTION**

indicates a possibly dangerous situation that can lead to slight (reversible) injury if the safety instruction is not followed.

#### **NOTE**

indicates a possibly dangerous situation where goods might be damaged if the actions mentioned are not taken.

#### 2.1.2 Safety signs on the meter

Note all labels, information signs and safety symbols on the meter. A warning symbol (triangle) without text refers to safety information in this operating manual.

#### 2.1.3 Further documents providing safety information

The following documents provide additional information, which you should observe for your safety when working with the measuring system:

- Operating manuals of sensors and other accessories
- Safety datasheets of calibration or maintenance accessories (such as buffer solutions, electrolyte solutions, etc.)

## 2.2 Safe operation

### 2.2.1 Authorized use

The authorized use of the meter consists exclusively of the measurement of the pH, ORP, conductivity and dissolved oxygen in a laboratory environment.

Only the operation and running of the meter according to the instructions and technical specifications given in this operating manual is authorized (see section 15 TECHNICAL DATA, page 135).

Any other use is considered unauthorized.

### **2.2.2 Requirements for safe operation**

Note the following points for safe operation:

- The meter may only be operated according to the authorized use specified above.
- The meter may only be supplied with power by the energy sources mentioned in this operating manual.
- The meter may only be operated under the environmental conditions mentioned in this operating manual.
- The meter may not be opened.

### **2.2.3 Unauthorized use**

The meter must not be put into operation if:

- it is visibly damaged (e.g. after being transported)
- it was stored under adverse conditions for a lengthy period of time (storing conditions, see section 15 TECHNICAL DATA, page 135).

## 3 Commissioning

### 3.1 Scope of delivery

- MultiLab 4010-3W
- USB cable (A plug on mini B plug)
- Power pack
- Stand with stand base
- Short instructions
- Comprehensive operating manual
- CD-ROM

### 3.2 Power supply

The MultiLab 4010-3W is supplied with power in the following ways:

- Mains operation with the supplied power pack
- In the case of power failure:  
The system clock is operated via a buffer battery (see section 13.1.2 EXCHANGING THE BATTERY, page 126).

### 3.3 Initial commissioning

Perform the following activities:

- Connect the power pack  
(see section 3.3.1 CONNECTING THE POWER PACK, page 13)
- Switch on the meter (see section 4.2 SWITCHING ON THE METER, page 19)
- Set the date and time (see section 4.4.5 EXAMPLE 2 ON NAVIGATION: SETTING THE DATE AND TIME, page 23)
- Mount the stand  
(see operating manual of the stand)

### 3.3.1 Connecting the power pack

**CAUTION**

The line voltage at the operating site must lie within the input voltage range of the original power pack (see section 15.2 GENERAL DATA, page 135).

**CAUTION**

Use original power packs only (see section 15.2 GENERAL DATA, page 135).

1. Connect the plug of the power pack to the socket for the power pack on the MultiLab 4010-3W.
2. Connect the original power pack to an easily accessible power outlet. The meter performs a self-test.



## 4 Operation

### 4.1 General operating principles

#### 4.1.1 Keypad

In this operating manual, keys are indicated by brackets <...> .

The key symbol (e.g. <ENTER>) generally indicates a short keystroke (press and release) in this operating manual. A long keystroke (press and keep depressed for approx. 2 sec) is indicated by the underscore behind the key symbol (e.g. <ENTER\_>).





<F1> <F4>	Softkeys providing situation dependent functions, e.g.: <F1>/[  ]: View information on a sensor
<On/Off> <On/Off_>	Switches the meter on or off (  )
<M>	Selects the measured parameter
<CAL> <CAL_>	Calls up the calibration procedure Displays the calibration data
<AR>	Freezes the measured value (HOLD function) Switches the AutoRead measurement on or off
<ESC>	Switches back to the higher menu level / Cancels inputs
<STO> <STO_>	Saves a measured value manually Opens the menu for the automatic save function
<RCL> <RCL_>	Displays the manually stored measured values Displays the automatically stored measured values
<▲><▼> <◀><▶>	Menu control, navigation
<ENTER> <ENTER_>	Opens the menu for measurement settings / Confirms entries Opens the menu for system settings
<PRT> <PRT_>	Outputs stored data to the interface Outputs displayed data to the interface at intervals

### 4.1.2 Display

Example  
pH

1 Status information (meter)  
2 Status information (sensor)  
3 Measured value  
4 Measured parameter  
5 Continuous measurement control (CMC function)  
6 Channel display: Plug position of the sensor  
7 Sensor symbol (calibration evaluation, calibration interval)  
8 Measured temperature (with unit)  
9 Softkeys and date + time

### 4.1.3 Status information

AutoCal e.g. YSI	Calibration with automatic buffer recognition, e.g. with the buffer set: YSI buffers
ConCal	Calibration with any buffers
Error	An error occurred during calibration
AR	Stability control (AutoRead) is active
HOLD	Measured value is frozen (<AR> key)
ZeroCal	The zero point is calibrated.
	Data are automatically output to the USB-B interface ( <i>USB Device</i> , e.g. PC) at intervals
	A USB memory device is connected to the USB-A interface ( <i>USB Host</i> , e.g. USB flash drive)
	Data are output to the USB-A interface ( <i>USB Host</i> , e.g. USB printer). If there is a connection via the USB-B interface at the same time (e.g. to a PC), the data are output to the USB-B interface only.
	Connection to a PC is active (USB-B interface)



Data transmission from / to an IDS sensor is active

#### 4.1.4 Connectors

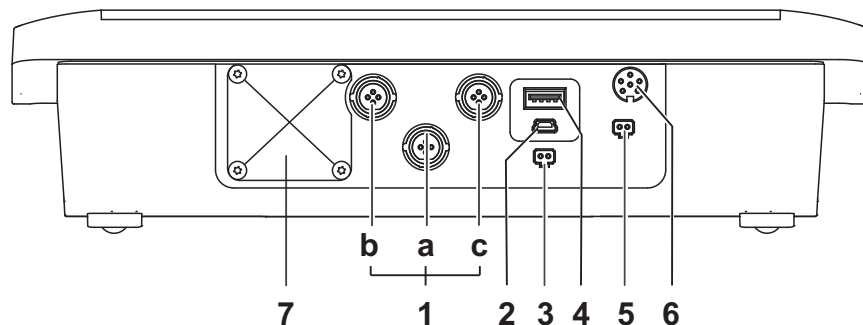

- 1 IDS sensors: (pH, ORP, conductivity, D.O.)
  - a) Channel 1
  - b) Channel 2
  - c) Channel 3

- 2 USB-B (*USB Device*) interface
- 3 Stirrer (interface for BOD sensor)
- 4 USB-A (*USB Host*) interface
- 5 Power pack
- 6 Service interface

- 7 Cover plate

The cover plate closes the mounting slot for the IDS adapter (4010-2/3 pH Adapter DIN or 4010-2/3 pH Adapter BNC) available as an accessory



#### CAUTION

Only connect sensors to the meter that cannot return any voltages or currents that are not allowed (> SELV and > current circuit with current limiting).

YSI IDS sensors and IDS adapters meet these requirements.



### 4.1.5 Channel display

The MultiLab 4010-3W manages the connected sensors and displays which sensor is plugged to which connection.

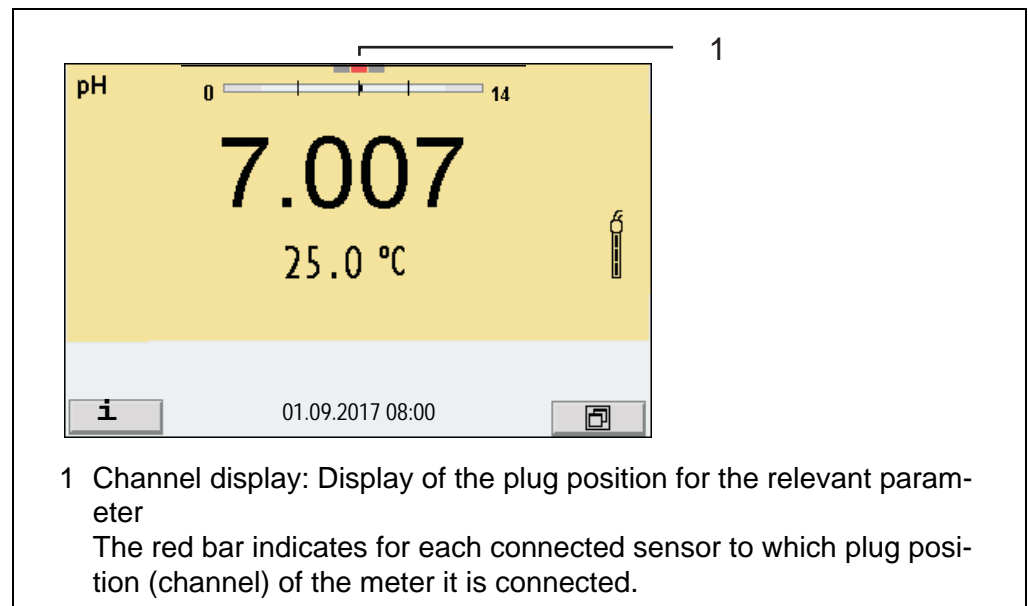

### 4.1.6 Sensor info

You can display the current sensor data and sensor settings of a connected sensor at any time. The sensor data are available in the measured value display with the **[i]** softkey.



1. In the measured value display:  
Display the sensor data (sensor name, serial number) with **[i]**.

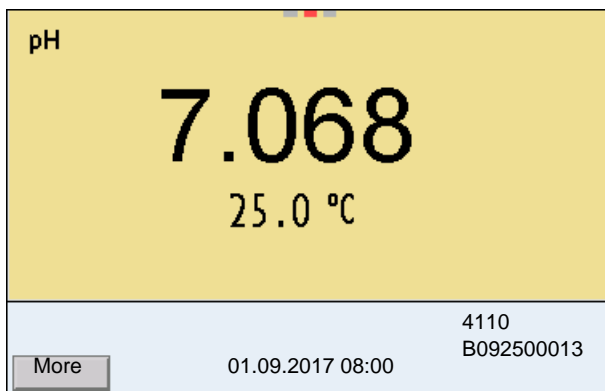

2. Display further sensor data (settings) with [More].

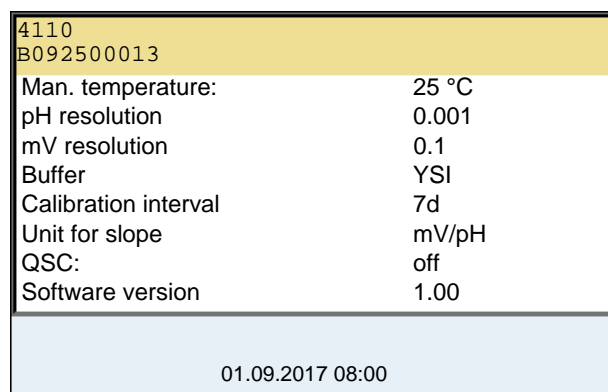

#### 4.1.7 Display of several sensors in the measuring mode

The measured values of the connected sensors can be displayed in the following ways:

- Clear display of all connected sensors
- Detailed display of one sensor (e.g. incl. CMC feature with pH sensors)

With the softkey you can very easily switch between the two display types. The suitable softkey is displayed depending on the operating situation.

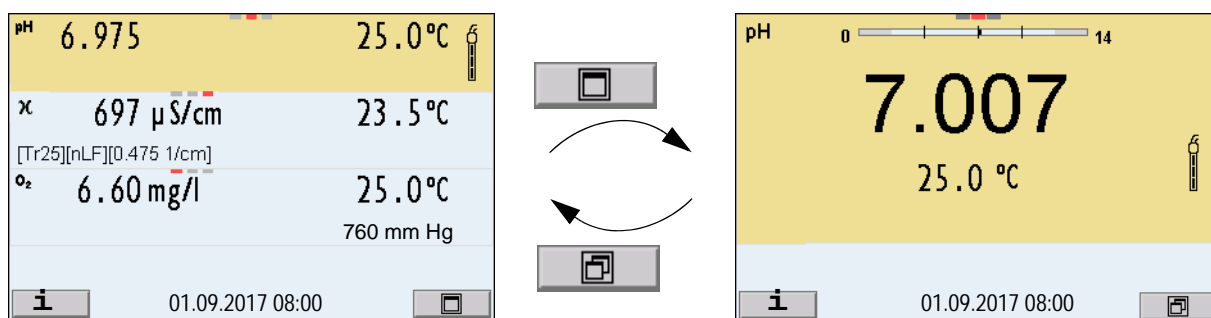

## 4.2 Switching on the meter

1. Switch the meter on with **<On/Off>**.  
The meter performs a self-test.
2. Connect the sensor.  
The meter is ready to measure.



## 4.3 Switching off the meter

1. Switch the printer off with **<On/Off>**.

## 4.4 Navigation

### 4.4.1 Operating modes

Operating mode	Explanation
<b>Measuring</b>	The measurement data of the connected sensor are shown in the measured value display
<b>Calibration</b>	The course of a calibration with calibration information, functions and settings is displayed
<b>Data storage</b>	The meter stores measuring data automatically or manually
<b>Transmitting data</b>	The meter transmits measuring data and calibration records to a USB interface automatically or manually.
<b>Setting</b>	The system menu or a sensor menu with submenus, settings and functions is displayed

### 4.4.2 Measured value display

In the measured value display, you can

- use <▲><▼> to select one of several connected sensors. The selected sensor is displayed with a colored background.  
The following actions / menus refer to the selected sensor
- open the menu for calibration and measurement settings with <ENTER> (short keystroke)
- open the system menu with the sensor-independent settings by pressing <ENTER> *Storage & config* for a <ENTER\_>long keystroke, approx. 2 s).
- change the display in the selected measuring screen (e. g. pH <-> mV) by pressing <M>.

#### 4.4.3 Menus and dialogs

The menus for settings and dialogs in procedures contain further subelements. The selection is done with the <▲><▼> keys. The current selection is displayed with a frame.

- Submenus  
The name of the submenu is displayed at the upper edge of the frame. Submenus are opened by confirming with <ENTER>. Example:

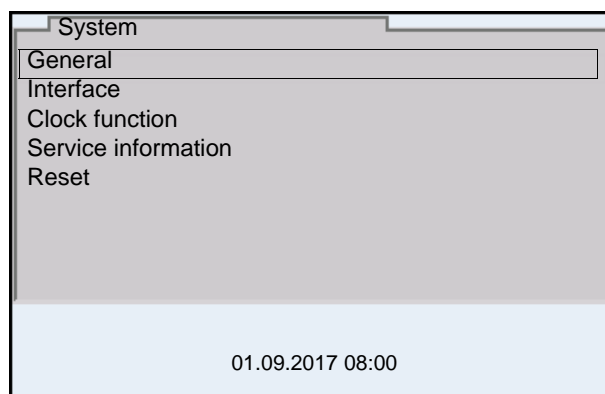

- Settings  
Settings are indicated by a colon. The current setting is displayed on the right-hand side. The setting mode is opened with <ENTER>. Subsequently, the setting can be changed with <▲><▼> and <ENTER>. Example:

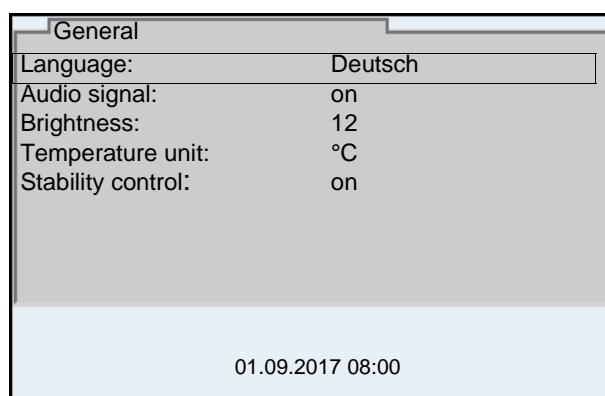

- Functions

Functions are designated by the name of the function. They are immediately carried out by confirming with **<ENTER>**. Example: Display the *Calibration record* function.

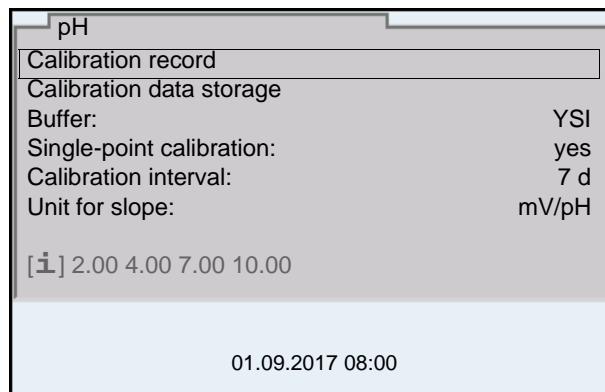

- Messages

Information is marked by the [i] symbol. It cannot be selected. Example:

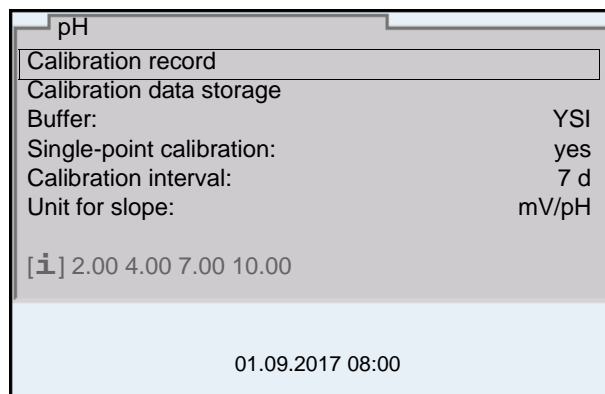

#### 4.4.4 Navigation example 1: Setting the language

1. Press the **<On/Off>** key.  
The measured value display appears.  
The instrument is in the measuring mode.

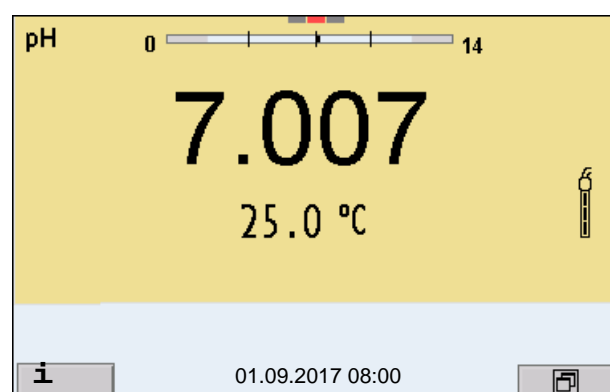

2. Open the *Storage & config* menu with **<ENTER\_>**.  
The instrument is in the setting mode.



3. Select the *System* submenu with **<▲><▼>**.  
The current selection is displayed with a frame.
4. Open the *System* submenu with **<ENTER>**.

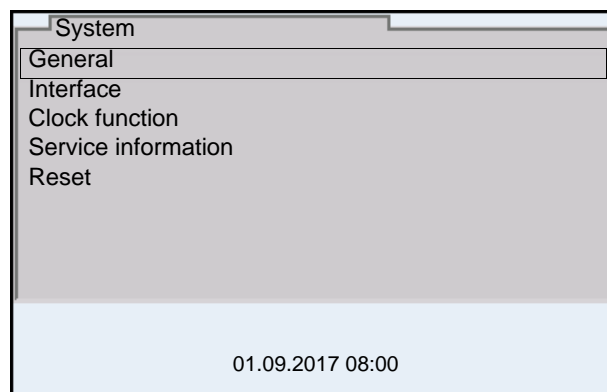

5. Select the *General* submenu with **<▲><▼>**.  
The current selection is displayed with a frame.
6. Open the *General* submenu with **<ENTER>**.

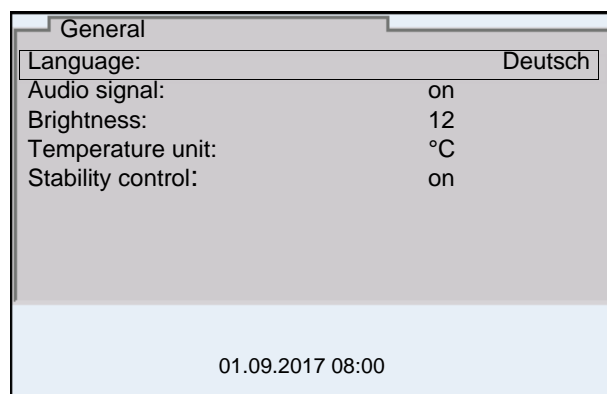

7. Open the setting mode for the *Language* with **<ENTER>**.

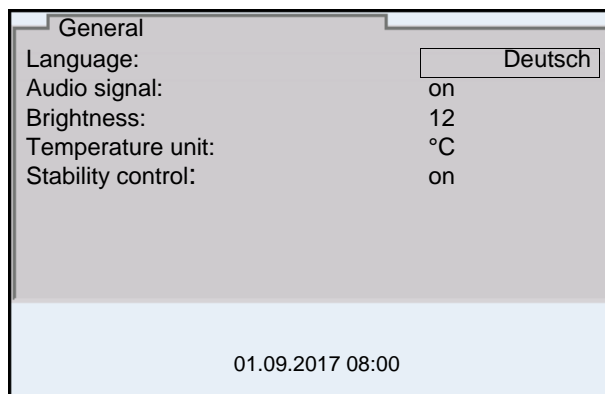

8. Select the required language with **<▲><▼>**.
9. Confirm the setting with **<ENTER>**.  
The meter switches to the measuring mode.  
The selected language is active.

#### 4.4.5 Example 2 on navigation: Setting the date and time

The meter has a clock with a date function. The date and time are indicated in the status line of the measured value display.

When storing measured values and calibrating, the current date and time are automatically stored as well.

The correct setting of the date and time and date format is important for the following functions and displays:

- Current date and time
- Calibration date
- Identification of stored measured values.

Therefore, check the time at regular intervals.



The date and time are reset if the following conditions are met:

- the supply voltage failed and
- the buffer batteries for the system clock are empty.

#### Setting the date, time and date format

The date format can be switched from the display of day, month, year (*dd.mm.yy*) to the display of month, day, year (*mm/dd/yy* or *mm.dd.yy*).

1. In the measured value display:  
Open the *Storage & config* menu with **<ENTER\_>**.  
The instrument is in the setting mode.
2. Select and confirm the *System / Clock function* menu with **<▲><▼>** and **<ENTER>**.  
The setting menu for the date and time opens up.

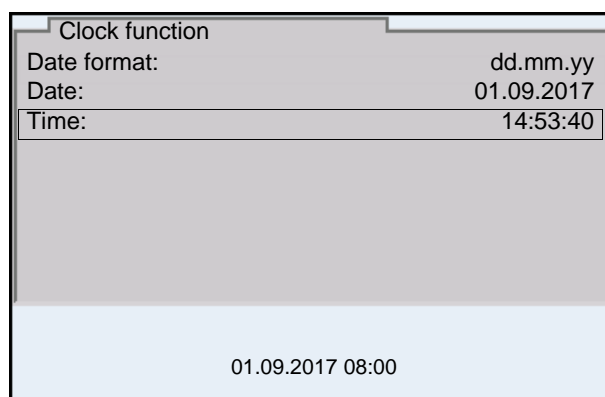

3. Select and confirm the *Time* menu with  $\langle \blacktriangle \rangle \langle \blacktriangledown \rangle$  and  $\langle \text{ENTER} \rangle$ . The hours are highlighted.
4. Change and confirm the setting with  $\langle \blacktriangle \rangle \langle \blacktriangledown \rangle$  and  $\langle \text{ENTER} \rangle$ . The minutes are highlighted.
5. Change and confirm the setting with  $\langle \blacktriangle \rangle \langle \blacktriangledown \rangle$  and  $\langle \text{ENTER} \rangle$ . The seconds are highlighted.
6. Change and confirm the setting with  $\langle \blacktriangle \rangle \langle \blacktriangledown \rangle$  and  $\langle \text{ENTER} \rangle$ . The time is set.
7. If necessary, set the *Date* and *Date format*. The setting is made similarly to that of the time.
8. To make further settings, switch to the next higher menu level with  $\langle \text{ESC} \rangle$ .  
or  
Switch to the measured value display with  $\langle \text{M} \rangle$ . The instrument is in the measuring mode.



## 5 pH value

### 5.1 Measuring

#### 5.1.1 Measuring the pH value



The sensor connection and the USB-B (*USB Device*) interface are galvanically insulated. This facilitates interference-free measurements also in the following cases:

- Measurement in grounded test samples
- Measurement with several sensors connected to one MultiLab 4010-3W in one test sample

1. Connect the IDS pH sensor to the meter. The pH measuring window is displayed.
2. If necessary, select the measured parameter with **<M>**.
3. Adjust the temperature of the solutions and measure the current temperature if the measurement is made without a temperature sensor.
4. If necessary, calibrate or check the IDS pH sensor.
5. Immerse the IDS pH sensor in the test sample.

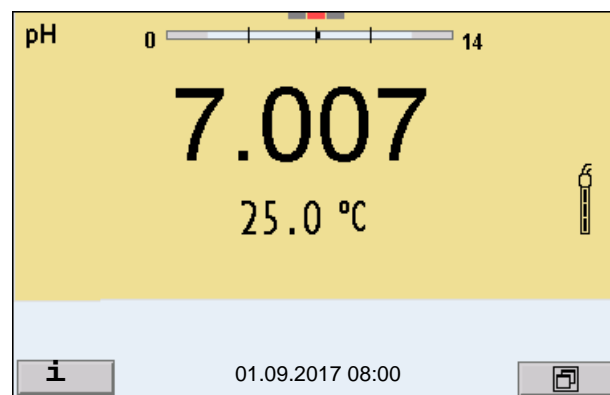

#### Stability control (AutoRead) & HOLD function

The stability control function (*AutoRead*) continually checks the stability of the measurement signal. The stability has a considerable impact on the reproducibility of measured values.

The measured parameter flashes on the display

- as soon as the measured value is outside the stability range
- when the automatic *Stability control* is switched off.

You can start the *Stability control* manually at any time, irrespective of the setting for automatic *Stability control* (see section 10.6.3 AUTOMATIC STABILITY CONTROL, page 110) in the *System* menu.

To start the *Stability control* function manually, the HOLD function must be enabled.

**Hold function**

1. Freeze the measured value with **<AR>**.  
The [HOLD] status indicator is displayed.  
The HOLD function is active.



You can terminate the HOLD function and the *Stability control* function with **<AR>** or **<M>** at any time.

**Stability control**

2. Using **<ENTER>**, activate the *Stability control* function manually. The [AR] status indicator appears while the measured value is assessed as not stable. A progress bar is displayed and the display of the measured parameter flashes.  
As soon as a measured value meets the stability criteria, it is frozen. The [HOLD][AR] status indicator is displayed, the progress bar disappears, the display of the measured parameter stops flashing, and there is a beep.  
The current measurement data is output to the interface. Measurement data meeting the stability control criterion is marked by AR.



You can prematurely terminate the *Stability control* function manually with **<ENTER>** at any time. If the *Stability control* function is prematurely terminated, the current measurement data are output to the USB-B (*USB Device*, e.g. PC) or USB-A (*USB Host*, e.g. USB memory device or USB printer) interface without AutoRead info.

You can switch off the beep (see section 10.6 SENSOR-INDEPENDENT SETTINGS, page 109).

3. Using **<ENTER>**, start a further measurement with stability control.  
or  
Release the frozen measured value again with **<AR>** or **<M>**.  
The [AR] status display disappears. The display switches back to the previous indication.

**Criteria for a stable measured value**

The *Stability control* function checks whether the measured values are stable within the monitored time interval.

Measured parameter	Time interval	Stability in the time interval
pH value	15 seconds	$\Delta$ : better than 0.01 pH
Temperature	15 seconds	$\Delta$ : better than 0.5 °C

The minimum duration until a measured value is assessed as stable is the monitored time interval. The actual duration is mostly longer.

## 5.1.2 Measuring the temperature

For reproducible pH measurements, it is essential to measure the temperature of the test sample.

IDS sensors measure the temperature with a temperature sensor integrated in the IDS sensor.

When operating a sensor without integrated temperature sensor, e.g. via an IDS-pH adapter, there are the following ways to measure the temperature of the test sample:

- Measurement of the temperature with the integrated temperature sensor of an IDS sensor.  
If the measured value is taken over from an IDS sensor, the status indicator [TP ↑ ] is displayed in the measurement window of the IDS-pH adapter. The status indicator [TP ↓ ] is displayed in the measurement window of the IDS-pH sensor providing the temperature value.
- Manual determination and input of the temperature.

The display of the temperature indicates the active temperature measuring mode:

Temperature sensor	Resolution of the temp. display	Temp. measurement
yes	0.1 °C	Automatic with temperature sensor
-	1 °C	Manual

If you wish to measure (or calibrate) without temperature sensor, proceed as follows:

1. Measure the current temperature of the test sample.
2. Set the temperature value with <▲><▼>.  
or  
In the <ENTER>//*Man. temperature* menu, set the temperature value with <▲><▼>.

## 5.2 pH calibration

### 5.2.1 Why calibrate?

pH electrodes age. This changes the zero point (asymmetry) and slope of the pH electrode. As a result, an inexact measured value is displayed. Calibration determines and stores the current values of the zero point and slope of the electrode.

Thus, you should calibrate at regular intervals.

### 5.2.2 When do you have to calibrate?

- Routinely within the framework of the company quality assurance
- When the calibration interval has expired

### 5.2.3 Calibration procedure

The MultiLab 4010-3W provides 2 calibration procedures:

- Automatic calibration (AutoCal)  
The buffer solutions used are automatically identified during the calibration procedure. The relevant nominal values are used automatically.  
**Prerequisite:** The buffer set used has been set in the meter (see section 10.1.2 BUFFER SETS FOR CALIBRATION, page 99).
- Manual calibration (ConCal)  
Any buffer solutions can be used. The nominal values of the buffer solutions are manually entered by the user during the calibration procedure.



For most applications, automatic calibration (AutoCal) is the safest and most convenient way of executing a calibration.

### 5.2.4 Carrying out automatic calibration (AutoCal)

Make sure that, in the menu for measurement and calibration settings (in the menu pH/<ENTER>/Calibration / Buffer), the correct buffer set is selected (see section 10.1.1 SETTINGS FOR PH MEASUREMENTS, page 97).

Use one to five buffer solutions of the selected buffer set in any order.

Below, calibration with YSI buffers (YSI) is described. When other buffer sets are used, other nominal buffer values are displayed. Apart from that, the procedure is identical.



If single-point calibration was set in the menu, the calibration procedure is automatically finished with the measurement of buffer solution 1 and the calibration record is displayed.

1. Connect the pH sensor to the meter.  
The pH measuring window is displayed.
2. Keep the buffer solutions ready.  
When measuring without temperature sensor:  
Temper the buffer solutions or measure the current temperature.
3. Start the calibration with <CAL>.  
The calibration display for the first buffer appears (voltage display).

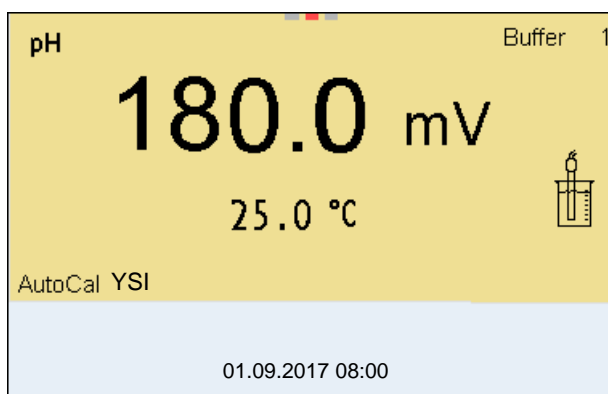

4. Thoroughly rinse the sensor with deionized water.
5. Immerse the sensor in the first buffer solution.
6. For measurements without temperature sensor (e.g. when using an IDS adapter):  
Enter the temperature of the buffer with  $\langle \blacktriangle \rangle \langle \blacktriangledown \rangle$ .
7. Start the measurement with  $\langle \text{ENTER} \rangle$ .  
The measured value is checked for stability (stability control).  
The [AR] status indicator is displayed. The measured parameter flashes.

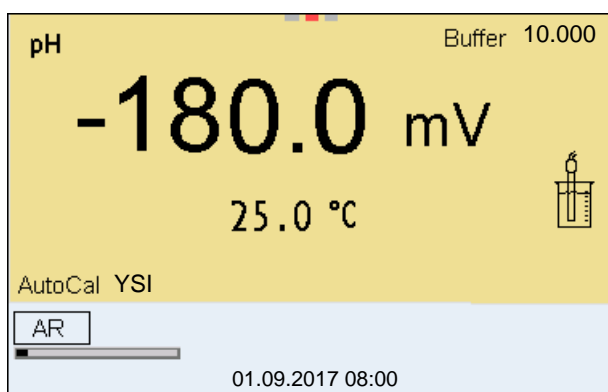

8. Wait for the end of the measurement with stability control (beep, [HOLD][AR] status indicator) or take over the calibrated value with  $\langle \text{ENTER} \rangle$ .  
The calibration display for the next buffer appears (voltage display).
9. If necessary, finish the calibration procedure as a single-point calibration with  $\langle \text{M} \rangle$ .  
The calibration record is displayed.



For **single-point calibration**, the instrument uses the Nernst slope (-59.2 mV/pH at 25 °C) and determines the zero point of the IDS-pH sensor.

### Continuing with two-point calibration

10. Thoroughly rinse the sensor with deionized water.

11. Immerse the pH sensor in buffer solution 2.
12. When measuring without temperature sensor:  
Enter the temperature of the buffer with <▲><▼>.
13. Start the measurement with <ENTER>.  
The measured value is checked for stability (stability control).  
The [AR] status indicator is displayed. The measured parameter flashes.

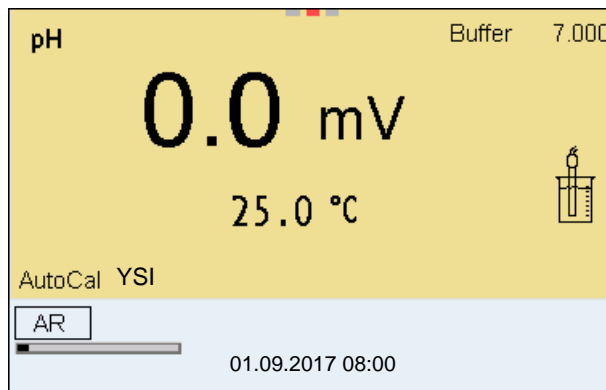

14. Wait for the end of the measurement with stability control (beep, [HOLD][AR] status indicator), or take over the calibrated value with <ENTER>.  
The calibration display for the next buffer appears (voltage display).
15. If necessary, finish the calibration procedure as a two-point calibration with <M>.  
The calibration record is displayed.

### Continuing with three- to five-point calibration

16. Thoroughly rinse the sensor with deionized water.
17. Immerse the sensor in the next buffer solution.
18. When measuring without temperature sensor:  
Enter the temperature of the buffer with <▲><▼>.
19. Start the measurement with <ENTER>.  
The measured value is checked for stability (stability control).  
The [AR] status indicator is displayed. The measured parameter flashes.

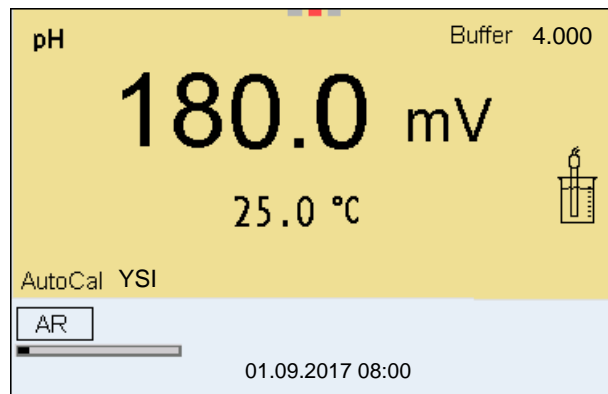

20. Wait for the end of the measurement with stability control (beep, [HOLD][AR] status indicator), or take over the calibrated value with **<ENTER>**.  
The calibration display for the next buffer appears (voltage display).
21. If necessary, use **<M>** to finish the calibration.  
The calibration record is displayed.  
or  
Switch to calibration with the next buffer with **<ENTER>**.



Calibration is automatically completed after the last buffer of a buffer set has been measured. Then the calibration record is displayed.

The calibration line is determined by linear regression.

### 5.2.5 Carrying out a manual calibration (ConCal)

Make sure that, in the menu for measurement and calibration settings (in the menu pH/**<ENTER>**/*Calibration / Buffer*) the buffer set ConCal is selected (see section 10.1.1 SETTINGS FOR PH MEASUREMENTS, page 97).

Use one to five buffer solutions in any order.

The pH values of the buffer solutions have to differ by at least one pH unit.



If single-point calibration was set in the menu, the calibration procedure is automatically finished with the measurement of buffer solution 1 and the calibration record is displayed.

1. Connect the pH sensor to the meter.  
The pH measuring window is displayed.
2. Keep the buffer solutions ready.  
When measuring without temperature sensor:  
Temper the buffer solutions or measure the current temperature.
3. Start the calibration with **<CAL>**.  
The calibration display for the first buffer appears (voltage display).

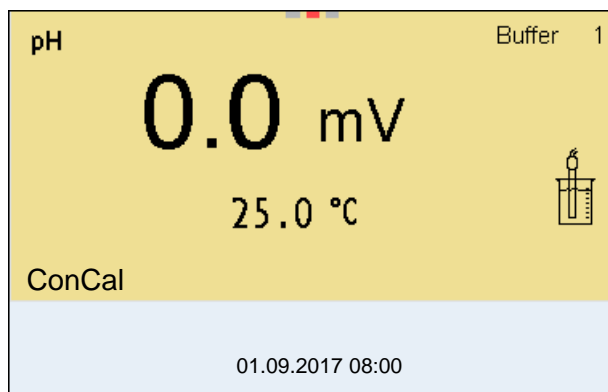

4. Thoroughly rinse the sensor with deionized water.
5. Immerse the pH sensor in buffer solution 1.
6. For measurements without temperature sensor (e.g. when using an IDS adapter):  
Enter the temperature of the buffer with <▲><▼>.
7. Start the measurement with <ENTER>.  
The measured value is checked for stability (stability control).  
The [AR] status indicator is displayed. The measured parameter flashes.

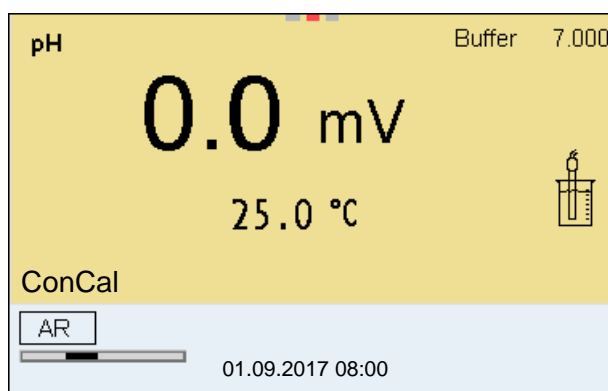

8. Wait for the end of the measurement with stability control (beep, [HOLD][AR] status indicator), or take over the calibrated value with <ENTER>.  
The pH value of the buffer solution is displayed.

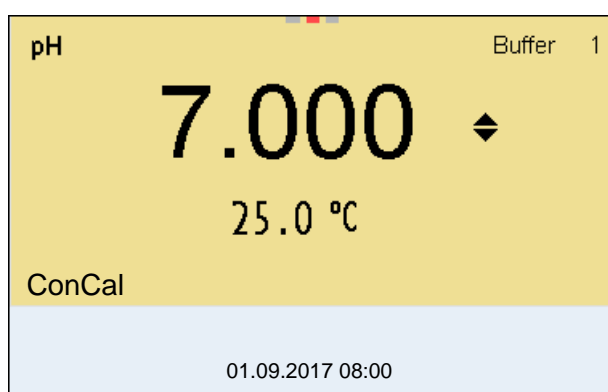



9. Set the nominal buffer value for the measured temperature with **<▲><▼>**.
10. Accept the calibration value with **<ENTER>**.  
The calibration display for the next buffer appears (voltage display).
11. If necessary, finish the calibration procedure as a single-point calibration with **<M>**.  
The calibration record is displayed.



For **single-point calibration**, the instrument uses the Nernst slope (-59.2 mV/pH at 25 °C) and determines the zero point of the IDS-pH sensor.

### Continuing with two-point calibration

12. Thoroughly rinse the sensor with deionized water.
13. Immerse the pH sensor in buffer solution 2.
14. When measuring without temperature sensor:  
Enter the temperature of the buffer with **<▲><▼>**.
15. Start the measurement with **<ENTER>**.  
The measured value is checked for stability (stability control).  
The [AR] status indicator is displayed. The measured parameter flashes.
16. Wait for the end of the measurement with stability control (beep, [HOLD][AR] status indicator), or take over the calibrated value with **<ENTER>**.  
The pH value of the buffer solution is displayed.

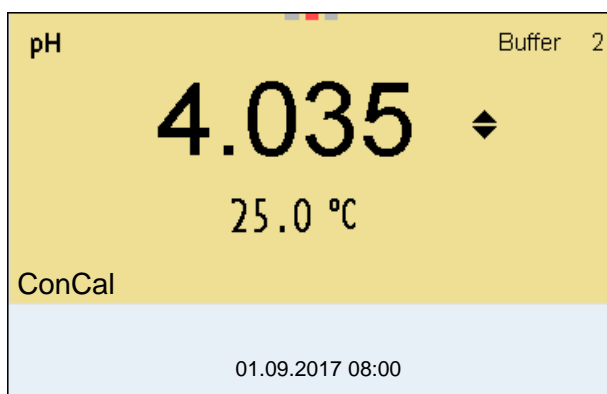

17. Set the nominal buffer value for the measured temperature with **<▲><▼>**.
18. Accept the calibration value with **<ENTER>**.  
The calibration display for the next buffer appears (voltage display).
19. If necessary, finish the calibration procedure as a two-point calibration with **<M>**.  
The calibration record is displayed.

### Continuing with three- to five-point calibration

20. Thoroughly rinse the sensor with deionized water.
21. Immerse the sensor in the next buffer solution.
22. When measuring without temperature sensor:  
Enter the temperature of the buffer with **<▲><▼>**.
23. Start the measurement with **<ENTER>**.  
The measured value is checked for stability (stability control).  
The [AR] status indicator is displayed. The measured parameter flashes.
24. Wait for the end of the measurement with stability control (beep, [HOLD][AR] status indicator), or take over the calibrated value with **<ENTER>**.  
The pH value of the buffer solution is displayed.

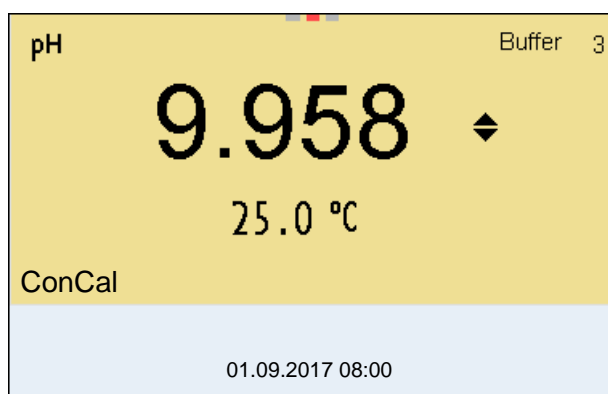

25. Set the nominal buffer value for the measured temperature with **<▲><▼>**.
26. Accept the calibration value with **<ENTER>**.  
The calibration display for the next buffer appears (voltage display).
27. If necessary, use **<M>** to finish the calibration.  
The calibration record is displayed.  
or  
Continue calibrating using the next buffer with **<ENTER>**.



After the fifth buffer has been measured the calibration is automatically finished. Then the calibration record is displayed.

The calibration line is determined by linear regression.

### 5.2.6 Calibration points

Calibration can be performed using one to five buffer solutions in any order (single-point to five-point calibration). The meter determines the following values and calculates the calibration line as follows:

Calibration	Determined values	Displayed calibration data
1-point	<i>Asymmetry</i>	<ul style="list-style-type: none"> <li>● Zero point = <i>Asymmetry</i></li> <li>● Slope = Nernst slope (-59.2 mV/pH at 25 °C)</li> </ul>
2-point	<i>Asymmetry</i> <i>Slope</i>	<ul style="list-style-type: none"> <li>● Zero point = <i>Asymmetry</i></li> <li>● Slope = <i>Slope</i></li> </ul>
3-point to 5-point	<i>Asymmetry</i> <i>Slope</i>	<ul style="list-style-type: none"> <li>● Zero point = <i>Asymmetry</i></li> <li>● Slope = <i>Slope</i></li> </ul> <p>The calibration line is calculated by linear regression.</p>



You can display the slope in the units, mV/pH or % (see section 10.1.1 SETTINGS FOR PH MEASUREMENTS, page 97).

### 5.2.7 Calibration data



The calibration record is automatically transmitted to the interface after calibrating.





The calibration record of the last calibration is available in the menu *Calibration / Calibration record*. To open it in the measured value display, press the **<CAL\_>** key.

The calibration records of the last 10 calibrations are available in the menu *Calibration // Calibration data storage*. To open the *Calibration* menu in the measured value display, press the **<ENTER>** key.

Menu item	Setting/function	Explanation
<i>Calibration / Calibration data storage / Display</i>	-	Displays the calibration records. Further options: <ul style="list-style-type: none"> <li>● Scroll through the calibration records with &lt;▲&gt;&lt;▼&gt;.</li> <li>● Using &lt;PRT&gt;, output the displayed calibration record to the interface USB-B (<i>USB Device</i>, e.g. PC) or USB-A (<i>USB Host</i>, e.g. USB printer).</li> <li>● Using &lt;PRT_&gt;, output all calibration records to the interface USB-B (<i>USB Device</i>, e.g. PC) or USB-A (<i>USB Host</i>, e.g. USB printer).</li> <li>● Quit the display with &lt;ESC&gt;.</li> <li>● Switch directly to the measured value display with &lt;M&gt;.</li> </ul>
<i>Calibration / Calibration data storage / Output to USB flash drive or printer</i>	-	Outputs the stored calibration data to the USB-A interface ( <i>USB Host</i> , e.g. USB memory device/USB printer) (see section 12 TRANSMITTING DATA, page 120).
<i>Calibration / Calibration data storage / Output to RS232/USB</i>	-	Outputs the stored calibration data to the USB-B interface ( <i>USB Device</i> , e.g. PC) (see section 12 TRANSMITTING DATA, page 120).

### Calibration evaluation

After calibrating, the meter automatically evaluates the calibration. The zero point and slope are evaluated separately. The worse evaluation of both is taken into account. The evaluation appears on the display and in the calibration record.

Display	Calibration record	Zero point [mV]	Slope [mV/pH]
	+++	-15 ... +15	-60.5 ... -58.0
	++	-20 ... <-15 or >+15 ... +20	>-58.0 ... -57.0
	+	-25 ... <-20 or >+20 ... +25	-61.0 ... <-60.5 or >-57.0 ... -56.0
	-	-30 ... <-25 or >+25 ... +30	-62.0 ... <-61.0 or >-56.0 ... -50.0

Display	Calibration record	Zero point [mV]	Slope [mV/pH]
Clean the IDS sensor according to the sensor operating manual			
<i>Error</i>	<i>Error</i>	<-30 or >+30	<-62.0 or > -50,0
Error elimination (see section 14 WHAT TO DO IF..., page 128)			



For pH IDS sensors you can optionally enable a more finely graded calibration evaluation (QSC) (see section 5.2.9 QSC FUNCTION (SENSOR QUALITY CONTROL), page 39).

### Calibration record

```

CALIBRATIONpH
01.09.2017 07:43:33
4110
Ser. no. B092500013

YSI
Buffer 1          4.00
Buffer 2          7.00
Buffer 3          10.00
Voltage 1         184.0 mV
Voltage 2         3.0 mV
Voltage 3        -177.0 mV
Temperature 1     24.0 °C
Temperature 2     24.0 °C
Temperature 3     24.0 °C

Slope             -60.2 mV/pH
Asymmetry         4.0 mV
Sensor            +++

etc...

```

### 5.2.8 Continuous measurement control (CMC function)

The Continuous Measurement Control (CMC function) facilitates to evaluate the current measured value instantly and definitely.

After each successful calibration the scale of the pH measuring range is displayed in the measured value display. Here you can very clearly see whether or not the current measured value is in the calibrated part of the measuring range.

The following information is displayed:

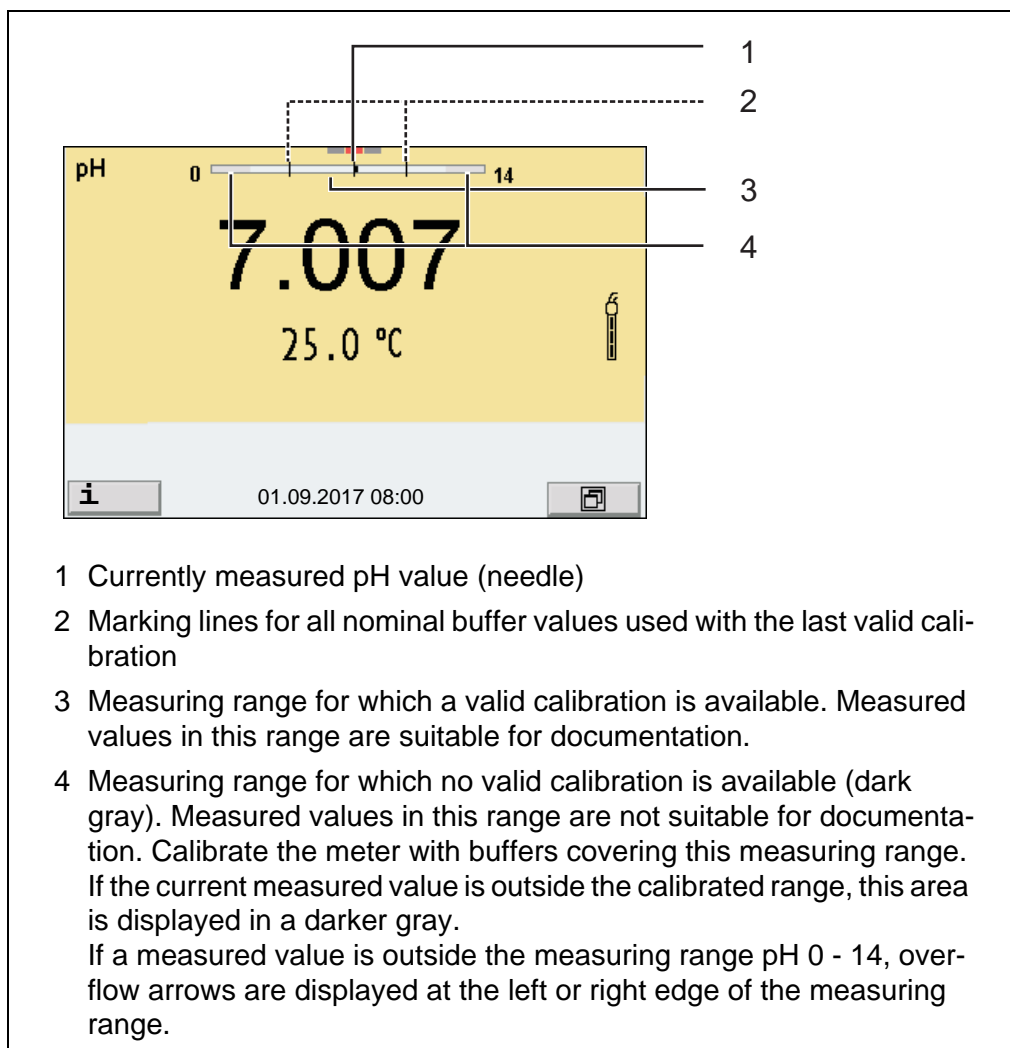

The limits of the calibrated range are determined by the buffers used for calibration:

Lower limit: Buffer with lowest pH value - 2 pH units

Upper limit: Buffer with highest pH value + 2 pH units

### 5.2.9 QSC function (sensor quality control)

#### General information on the QSC function

The QSC function (Quality Sensor Control) is a new sensor evaluation for digital IDS sensors. It evaluates the condition of an IDS pH sensor individually and with a very fine grading.

The QSC scale shows the current sensor evaluation with an indicator on the display.

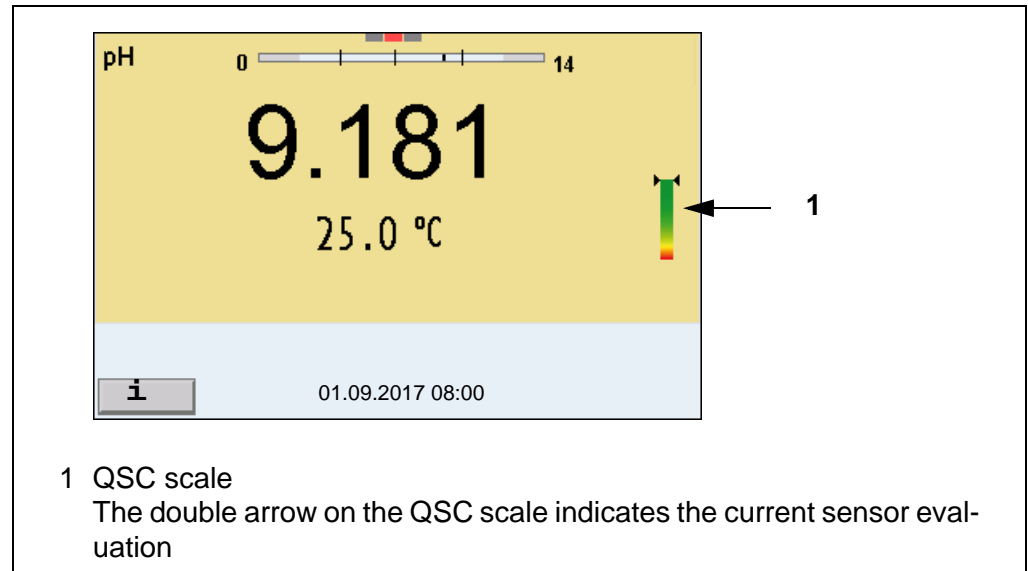

In the USB output the sensor evaluation is given as a percentage (1-100).

The finely graded sensor evaluation of the QSC function promptly calls your attention to changes of the sensor.

Thus you can do what is necessary to restore the optimum measuring quality (e.g. clean, calibrate or replace the sensor). clean, calibrate or replace the sensor).

#### Sensor evaluation with / without QSC function

With QSC function	Without QSC function (sensor symbol)
Very fine grading of the sensor evaluation (100 grades)	Rough grading of the sensor evaluation (4 grades)
The reference value is individually determined for each sensor during the QSC initial calibration.	A theoretical reference value is used for all sensors
Low tolerances for zero point and slope when using QSC buffer solutions	Greater tolerances for zero point and slope when using commercial buffer sets
Additional QSC calibration required (with special QSC buffer set)	No additional calibration required

#### QSC calibration

The QSC function is enabled by once carrying out an additional three-point calibration with special QSC buffer solutions. It covers the measuring range of the sensor from pH 2 to pH 11. The QSC initial calibration determines the actual condition of the sensor and stores it as a reference in the sensor. To meet the high requirements of a QSC initial calibration, the QSC initial cali-

bration should optimally be carried out with the initial commissioning of the sensor.

Carry out the normal calibrations for your special measuring range with your usual standard solutions as previously done.



As soon as the QSC function was enabled for an IDS sensor, it is not possible to return to the sensor evaluation with the sensor symbol for this sensor.

### Carrying out a QSC initial calibration



Carry out the QSC initial calibration very carefully. It determines the reference value for the sensor. This reference value cannot be overwritten or reset.

As soon as the QSC function was enabled, it is not possible to return to the sensor evaluation with the sensor symbol.

1. Prepare for calibration the meter, sensor and the buffer solutions of the QSC-Kit.
2. Open the menu for measurement settings with **<ENTER>**.
3. In the QSC menu, select *First calibration* with **<▲><▼>**.  
The calibration display appears. *AutoCal QSC-Kit* is displayed as the buffer.  
Exclusively use the QSC-Kit for the QSC calibration. If you use other buffers, you will have no valid QSC calibration.

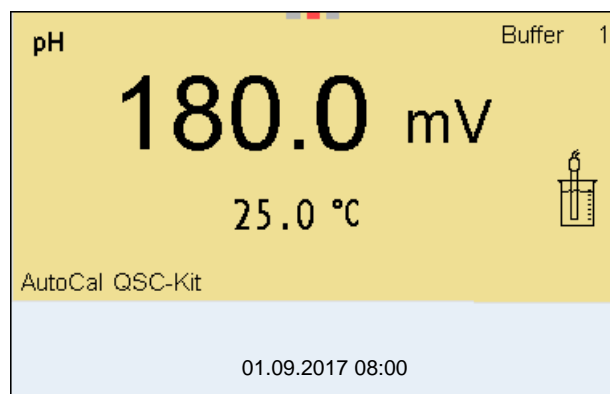

4. Start the measurement with **<ENTER>**.  
Calibration with the buffers of the QSC-Kit is done like a normal three-point calibration (see section 5.2.4 CARRYING OUT AUTOMATIC CALIBRATION (AUTOCAL), page 28).
5. As soon as the three-point calibration has been successfully carried out you can decide whether to accept or discard the calibration as the QSC initial calibration.

The QSC initial calibration is completed. The sensor is calibrated. If you want to calibrate with special buffers for your measurements, you can subsequently carry out a normal calibration with your buffers. The reference values deter-



mined with the QSC calibration are also used for the evaluation of normal calibrations. In the measured value display, the QSC scale of the QSC function is always displayed. A double arrow on the QSC scale indicates the current sensor evaluation.

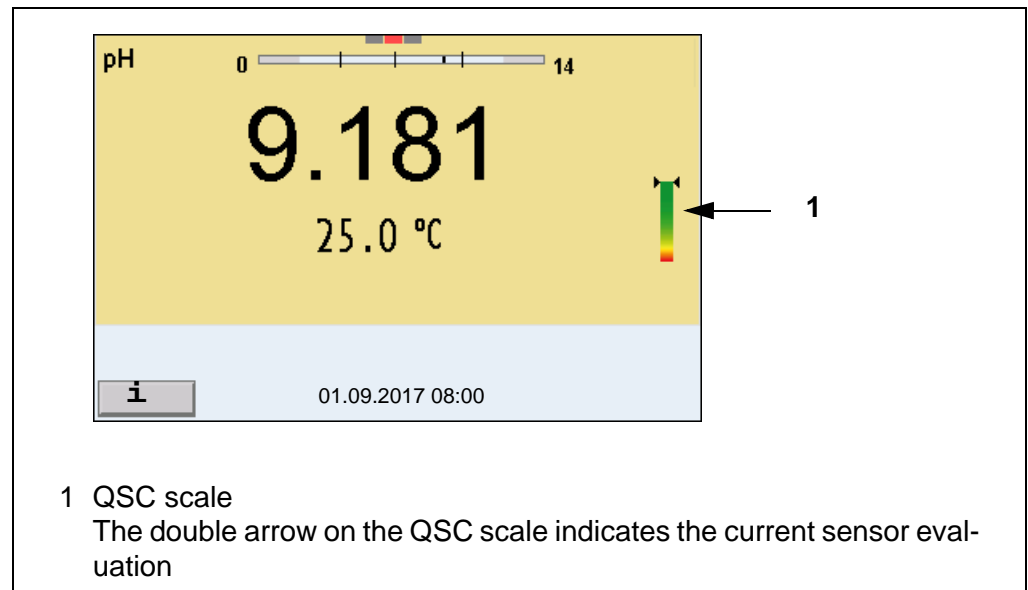

### Carrying out a QSC control calibration

A QSC control calibration can, e.g. be useful if the sensor evaluation noticeably changed (after some normal calibrations).

You can carry out QSC control calibrations at greater intervals than normal calibrations.

1. Prepare for calibration the meter, sensor and the buffer solutions of the QSC-Kit.
2. Open the menu for measurement settings with **<ENTER>**.
3. In the QSC menu, select *Control calibration* with **<▲><▼>**.  
The calibration display appears. *AutoCal QSC-Kit* is displayed as the buffer.  
Exclusively use the QSC-Kit for the QSC calibration. If you use other buffers, you will have no valid QSC control calibration.
4. Start the measurement with **<ENTER>**.  
Calibration with the buffers of the QSC-Kit is done like a normal three-point calibration (see section 5.2.4 CARRYING OUT AUTOMATIC CALIBRATION (AUTOCAL), page 28).

As soon as the three-point calibration has been successfully carried out you can decide whether to accept or discard the calibration as the QSC control calibration.

## 6 ORP

### 6.1 Measuring

#### 6.1.1 Measuring the ORP



The sensor connection and the USB-B (*USB Device*) interface are galvanically insulated. This facilitates interference-free measurements also in the following cases:

- Measurement in grounded test samples
- Measurement with several sensors connected to one MultiLab 4010-3W in one test sample



IDS ORP sensors are not calibrated. However, you can check IDS ORP sensors using a test solution.

1. Connect the ORP sensor to the meter.  
The ORP measuring window is displayed.
2. Adjust the temperature of the solutions and measure the current temperature if the measurement is made without a temperature sensor.
3. Check the meter with the ORP sensor.
4. Immerse the ORP sensor in the test sample.



#### Stability control (AutoRead) & HOLD function

The stability control function (*AutoRead*) continually checks the stability of the measurement signal. The stability has a considerable impact on the reproducibility of measured values.

The measured parameter flashes on the display

- as soon as the measured value is outside the stability range
- when the automatic *Stability control* is switched off.

You can start the *Stability control* manually at any time, irrespective of the setting for automatic *Stability control* (see section 10.6.3 AUTOMATIC STABILITY CONTROL, page 110) in the *System* menu.

To start the *Stability control* function manually, the HOLD function must be enabled.

### Hold function

1. Freeze the measured value with **<AR>**.  
The [HOLD] status indicator is displayed.  
The HOLD function is active.



You can terminate the *Stability control* function and the HOLD function with **<AR>** or **<M>** at any time.

### Stability control

2. Using **<ENTER>**, activate the *Stability control* function manually. The [AR] status indicator appears while the measured value is assessed as not stable. A progress bar is displayed and the display of the measured parameter flashes.  
As soon as a measured value meets the stability criteria, it is frozen. The [HOLD][AR] status indicator is displayed, the progress bar disappears, the display of the measured parameter stops flashing, and there is a beep.  
The current measurement data is output to the interface. Measurement data meeting the stability control criterion is marked by AR.



You can prematurely terminate the *Stability control* function manually with **<ENTER>** at any time. If the *Stability control* function is prematurely terminated, the current measurement data are output to the interfaces USB-B (*USB Device*, e.g. PC) and USB-A (*USB Host*, e.g. USB memory device or USB printer) without AutoRead info.

You can switch off the beep (see section 10.6 SENSOR-INDEPENDENT SETTINGS, page 109).

3. Using **<ENTER>**, start a further measurement with stability control.  
or  
Release the frozen measured value again with **<AR>** or **<M>**.  
The [AR] status display disappears. The display switches back to the previous indication.

### Criteria for a stable measured value

The *Stability control* function checks whether the measured values are stable within the monitored time interval.

Measured parameter	Time interval	Stability in the time interval
ORP	15 seconds	$\Delta$ : better than 0.3 mV
Temperature	15 seconds	$\Delta$ : better than 0.5 °C

The minimum duration until a measured value is assessed as stable is the monitored time interval. The actual duration is mostly longer.

### 6.1.2 Measuring the relative ORP

To measure the difference of the ORPs of two solutions, you have to define the ORP of one solution as the zero point first.



ORP electrodes can be used to determine the relative ORP.

1. Connect the ORP electrode to the meter.
2. Prepare the reference solution for the determination of the reference point.
3. Select the  $\Delta U$  (mV display with **<M>**).
4. Immerse the ORP electrode in the reference solution.
5. Display the potential of the current zero point with **<CAL>**.
6. Press **<ENTER>** to measure the reference solution.  
The measured value is checked for stability (automatic stability control). The display of the measured parameter flashes.  
The measured potential is defined as the zero point.  
or  
Press **<M>** to terminate the display of the zero point.
7. Rinse the ORP electrode and immerse it in the test sample.  
The measured value is checked for stability (automatic stability control). The display of the measured parameter flashes.
8. Wait for a stable measured value.  
The display of the measured parameter no longer flashes.



**AutoRead** The *Stability control* function checks whether the measured values are stable within the monitored time interval.

Measured parameter	Time interval	Stability in the time interval
ORP	15 seconds	$\Delta$ : better than 0.3 mV
Temperature	15 seconds	$\Delta$ : better than 0.5 °C

The minimum duration until a measured value is assessed as stable is the monitored time interval. The actual duration is mostly longer.

### 6.1.3 Measuring the temperature

For reproducible ORP measurements, it is essential to measure the temperature of the test sample.

When a sensor with integrated temperature sensor is operated, the temperature value is displayed and recorded together with the measured value.

## 6.2 ORP calibration



ORP electrodes are not calibrated. You can, however, check ORP electrodes by measuring the ORP of a test solution and comparing the value with the nominal value.

## 7 Ion concentration

### 7.1 Measuring

#### 7.1.1 Measuring the ion concentration



The sensor connection and the USB-B (*USB Device*) interface are galvanically insulated. This facilitates interference-free measurements also in the following cases:

- Measurement in grounded test samples
- Measurement with several sensors connected to one MultiLab 4010-3W in one test sample



Incorrect calibration of ion sensitive electrodes will result in incorrect measured values. Calibrate regularly before measuring.



For precise ISE measurements the temperature difference between measurement and calibration should not be greater than 2 °C. Therefore, adjust the temperature of the standard and measuring solutions accordingly. If the temperature difference is greater the *[TempErr]* warning appears in the measured value display.

1. Connect an ISE combination electrode to the meter with the aid of a 4010-2/3 pH Adapter BNC or 4010-2/3 pH Adapter DIN. The pH/ISE measuring window is displayed.
2. In the measured value display, select the ISE measuring window with **<▲><▼>** and **<M>**.
3. Specify the ion type in the *ISE setup/Ion type* menu as necessary.
4. If necessary, measure the temperature of the test sample with a thermometer.
5. Calibrate or check the meter with the electrode.



While no valid calibration is available, e.g. in the delivery condition, "Error" appears in the measured value display.

6. Immerse the electrode in the test sample.

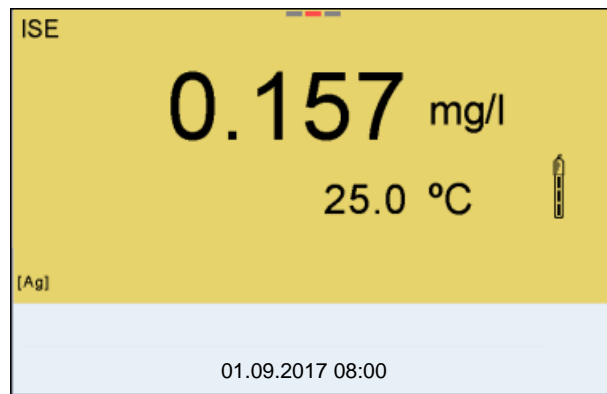

### Stability control (AutoRead) & HOLD function

The stability control function (*AutoRead*) continually checks the stability of the measurement signal. The stability has a considerable impact on the reproducibility of measured values.

The measured parameter flashes on the display

- as soon as the measured value is outside the stability range
- when the automatic *Stability control* is switched off.

You can activate or switch off the automatic *Stability control* function (see section 10.6.3 AUTOMATIC STABILITY CONTROL, page 110).

To start the *Stability control* function manually, the HOLD function must be enabled.

### Hold function

1. Freeze the measured value with **<AR>**.  
The [HOLD] status indicator is displayed.  
The HOLD function is active.



You can terminate the *Stability control* function and the HOLD function with **<AR>** or **<M>** at any time.

### Stability control

2. Using **<ENTER>**, activate the *Stability control* function manually. The [AR] status indicator appears while the measured value is assessed as not stable. A progress bar is displayed and the display of the measured parameter flashes. The [HOLD][AR] status indicator appears as soon as a stable measured value is recognized. The progress bar disappears, the display of the measured parameter stops flashing, and there is a beep. The current measurement data is output to the interface. Measurement data meeting the stability control criterion is marked by AR.



You can prematurely terminate the *Stability control* function manually with **<ENTER>** at any time. If the *Stability control* function is prematurely terminated, the current measurement data are output to the interface without the AutoRead info.

You can switch off the beep (see section 10.6 SENSOR-INDEPENDENT SETTINGS, page 109).

- Using **<ENTER>**, start a further measurement with stability control.  
or  
Release the frozen measured value again with **<AR>** or **<M>**.  
The [AR] status display disappears. The display switches back to the previous indication.

**Criteria** The AutoRead criteria affect the reproducibility of the measured values. The following criteria can be adjusted in the menu for measurement and calibration settings (menu **<ENTER>/ISE setup/AutoRead criterion**):

- *high*: highest reproducibility
- *medium*: medium reproducibility
- *low*: lowest reproducibility



Increasing reproducibility also causes the response time to increase until a measured value is evaluated as stable.

### 7.1.2 Measuring the temperature

For reproducible ion-selective measurements, it is essential to measure the temperature of the test sample.

Most IDS sensors measure the temperature with a temperature sensor integrated in the IDS sensor.

When operating a sensor without integrated temperature sensor, e.g. via an IDS-pH adapter, there are the following ways to measure the temperature of the test sample:

- Measurement of the temperature with the integrated temperature sensor of an IDS sensor.  
If the measured value is taken over from an IDS sensor, the status indicator [TP ↑ ] is displayed in the measurement window of the IDS-pH adapter. The status indicator [TP ↓ ] is displayed in the measurement window of the IDS-pH sensor providing the temperature value.
- Manual determination and input of the temperature.

The measuring instrument recognizes whether a suitable sensor is connected and automatically switches on the temperature measurement.



The display of the temperature indicates the active temperature measuring mode:

Temperature sensor	Resolution of the temp. display	Temp. measurement
yes	0.1 °C	Automatic with temperature sensor
-	1 °C	Manual

If you wish to measure (or calibrate) without temperature sensor, proceed as follows:

1. Measure the current temperature of the test sample.
2. Set the temperature value with <▲><▼>.  
or  
In the <ENTER>//*Man. temperature* menu, set the temperature value with <▲><▼>.

## 7.2 Calibration

### 7.2.1 Why calibrate?

Ion-selective electrodes age and are temperature-dependent. This changes the slope. As a result, an inexact measured value is displayed. Calibration determines the calibration line of the electrode and stores this value in the meter.

Thus, you should calibrate before each measurement (if possible), and at regular intervals.

### 7.2.2 When to calibrate?

- Before any measurement if possible
- After connecting another ISE electrode

### 7.2.3 Calibration (ISE Cal)

ISE Cal is the conventional **two-point to seven-point calibration procedure** that uses 2 to 7 freely selectable standard solutions. The concentration expected in the measurement determines the concentration of the calibration standards.

For calibration with 3 or more points, the standards have to be selected either in increasing or decreasing order.

1. Connect the ISE electrode to the meter.  
The pH/mV/ISE measuring window is displayed.
2. Keep the standard solutions ready.
3. If necessary, measure the temperature of the standard solutions with a thermometer.
4. In the measured value display, select the ISE measuring window with **<▲><▼>** and **<M>**.
5. Specify the ion type in the *ISE setup/Ion type* menu as necessary.
6. If necessary, change the unit of the measurement result and calibration standards in the *ISE setup/Unit* menu.
7. Start the calibration with **<CAL>**.  
The calibration display appears.

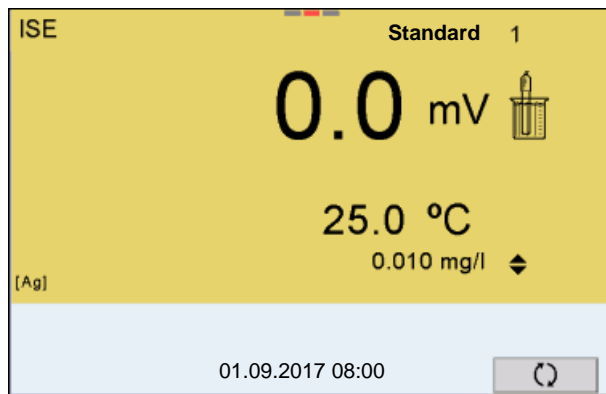

8. Thoroughly rinse the electrode with distilled water.
9. Immerse the electrode in standard solution 1.
10. When calibrating without temperature sensor:
  - Measure the temperature of the standard solution using a thermometer.
  - Use <F4>/[↕] to select the setting of the temperature.
  - Use <▲><▼> to set the temperature.
  - Use <F4>/[↕] to select the setting of the concentration.
11. Set the concentration of the standard solution with <▲><▼> and press <ENTER>. The standard solution is measured. The measured value is checked for stability (AutoRead).

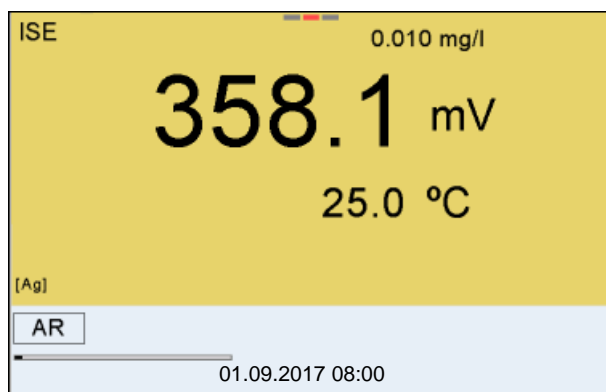

12. Wait for the end of the measurement with stability control ([HOLD][AR]) status indicator or take over the calibrated value with <ENTER>. The calibration display for the next standard solution appears.

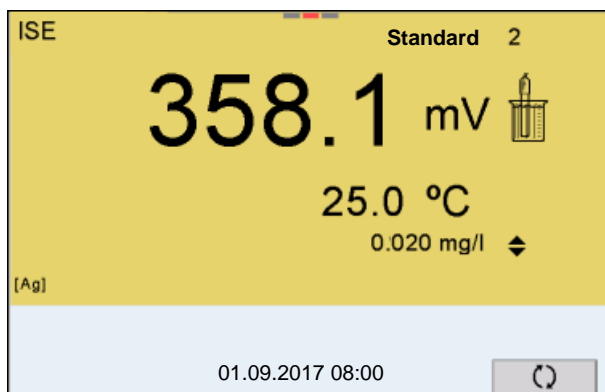

### Continuing with two-point calibration

13. Thoroughly rinse the electrode with distilled water.
14. Immerse the electrode in standard solution 2.
15. When calibrating without temperature sensor:
  - Measure the temperature of the standard solution using a thermometer.
  - Use <F4>/[  $\updownarrow$  ] to select the setting of the temperature.
  - Use <▲><▼> to set the temperature.
  - Use <F4>/[  $\updownarrow$  ] to select the setting of the concentration.
16. Set the concentration of the standard solution with <▲><▼> and press <ENTER>. The standard solution is measured. The measured value is checked for stability (AutoRead).

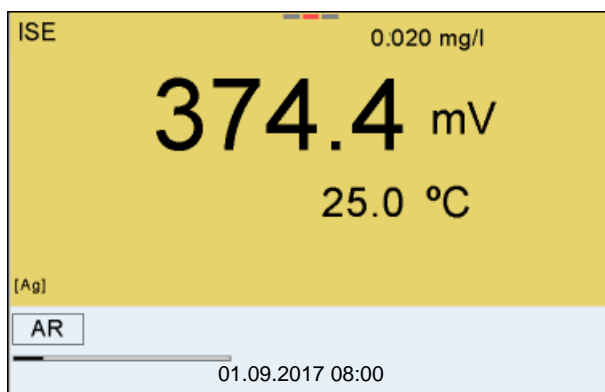

17. Wait for the end of the measurement with stability control (beep, [HOLD][AR] status indicator) or take over the calibrated value with <ENTER>. The calibration display for the next standard solution appears.

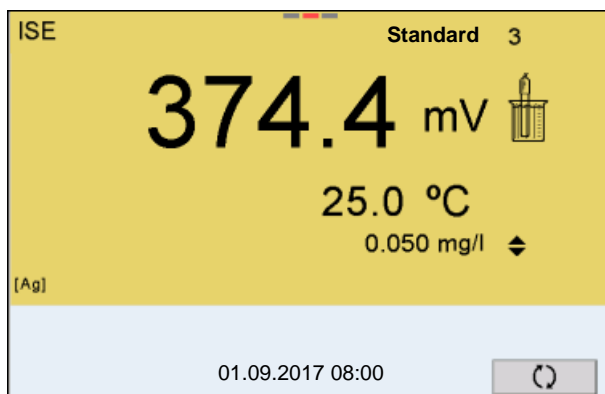

18. Press **<ENTER>** to continue with three-point calibration.  
or  
Finish the calibration procedure as a two-point calibration with **<M>**.  
The new calibration values are displayed.

### Continuing with three- to seven-point calibration

Repeat the steps 12 to 17 in the same way with the third and further standard solutions as necessary. The new calibration values are displayed after the last calibration step was completed.



Based on the calibration data, the calibration curve is determined in sections, according to the Nernst equation modified by Nikolski.

### 7.2.4 Calibration standards

Use two to seven different standard solutions. The standard solutions have to be selected in either increasing or decreasing order.



Select the unit of the standard solution and measurement result in the *ISE setup/Unit* menu.

Standard solution (Std 1 - 7)	Values
Unit [mg/l]	0.010 ... 500,000
Unit [mol/l]	0.100 ... 5.000 µmol/l 10.00 ... 5.000 mmol/l
Unit [mg/kg]	0.010 ... 500.000
Unit [ppm]	0.010 ... 500.000
Unit [%]	0.001 ... 50.000



The measurement precision is also dependent on the selected standard solutions. Therefore, the selected standard solutions should cover the value range expected of the following concentration measurement.

If the measured electrode potential is outside the calibrated range, the *[ISEErr]* warning is displayed.

### 7.2.5 Calibration data



The calibration record is automatically transmitted to the interface after calibrating.



The calibration record of the last calibration is available in the menu *Calibration / Calibration record*. To open it in the measured value display, press the **<CAL\_>** key.

The calibration records of the last 10 calibrations are available in the menu *Calibration / Calibration data storage*. To open the *Calibration* menu in the measured value display, press the **<ENTER>** key.

Menu item	Setting/function	Explanation
<i>Calibration / Calibration data storage / Display</i>	-	Displays the calibration records. Further options: <ul style="list-style-type: none"> <li>● Scroll through the calibration records with <b>&lt;◀&gt;&lt;▶&gt;</b>.</li> <li>● Using <b>&lt;PRT&gt;</b>, output the displayed calibration record to the interface USB-B (<i>USB Device</i>, e.g. PC) or USB-A (<i>USB Host</i>, e.g. USB printer).</li> <li>● Using <b>&lt;PRT_&gt;</b>, output all calibration records to the interface USB-B (<i>USB Device</i>, e.g. PC) or USB-A (<i>USB Host</i>, e.g. USB printer).</li> <li>● Quit the display with <b>&lt;ESC&gt;</b>.</li> <li>● Switch directly to the measured value display with <b>&lt;M&gt;</b>.</li> </ul>
<i>Calibration / Calibration data storage / Output to USB flash drive or printer</i>	-	Outputs the stored calibration data to the USB-A interface ( <i>USB Host</i> , e.g. USB memory device/USB printer) (see section 12 TRANSMITTING DATA, page 120).
<i>Calibration / Calibration data storage / Output to RS232/USB</i>	-	Outputs the stored calibration data to the USB-B interface ( <i>USB Device</i> , e.g. PC) (see section 12 TRANSMITTING DATA, page 120).

**Calibration evaluation**

After calibrating, the meter automatically evaluates the calibration.

Display	Calibration record	Calibration evaluation	Magnitude of the slope [mV]
	+++	<b>Excellent</b>	50.0 ... 70.0 * or 25.0 ... 35.0 **
	-	<b>Poor</b> (Measurement accuracy restricted) ● Eliminate the sources of error (see section 14.2 ISE, page 130). ● Recalibrate.	30.0 ... 50.0 or 70.0 ... 90.0 *; or 15.0 ... 25.0 or 35.0 ... 45.0 **
<i>Error</i>	<i>Error</i>	<b>Failed</b> (Measuring not possible) Error elimination (see section 14.2 ISE, page 130)	< 30 or > 90 * or < 15 or > 45 **

\* Monovalent ions

\*\* Bivalent ions

**Calibration record (example)**

```

4010-3W
Ser. no. 12345678

CALIBRATIONISE
01.09.2017 08:09:10

Sensor
Ser. no. 12345678

Standard 1          0.010 mg/l
Standard 2          0.020 mg/l
Voltage 1           358.1 mV
Voltage 2           374.4 mV
Temperatur 1        25.0 øC
Temperatur 2        25.0 øC
Ion type            Ag
Slope               54.1 mV
Sensor              +++

```

### 7.3 Selecting the measuring method

The following methods are supported:

- *Standard addition*
- *Standard subtraction*
- *Sample addition*
- *Sample subtraction*
- *Blank value addition*

1. Connect the ISE electrode to the meter.  
The pH/ISE measuring window is displayed.
2. If necessary, select the ISE display with <M>.
3. If necessary, measure the temperature of the test sample with a thermometer.
4. Open the ISE menu with <ENTER>.
5. Thoroughly rinse the electrode with distilled water.
6. Adjust the temperature of the standard solutions.
7. Select *Method* with <▲><▼> and confirm with <ENTER>.
8. Select a method with <▲><▼> and confirm with <ENTER>.

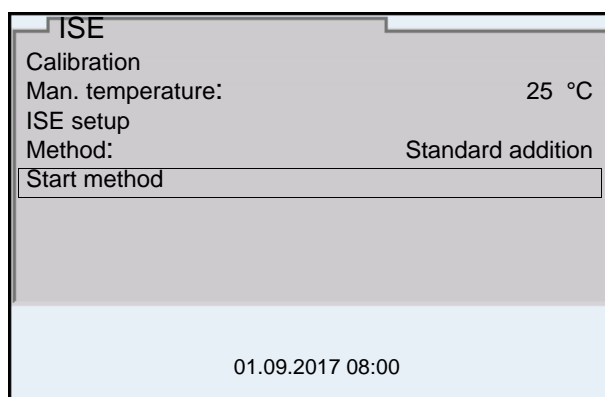

9. Select *Start method* with <▲><▼> and confirm with <ENTER>. Measurement with the selected method begins (see section 7.3.1 STANDARD ADDITION, page 57 ... section 7.3.5 STANDARD ADDITION WITH BLANK VALUE CORRECTION (BLANK VALUE ADDITION), page 66).



### 7.3.1 Standard addition

In the "Standard addition" procedure, a known amount of standard solution is added to the sample.

The ion concentration in the sample is calculated from the change in potential.

1. Select the measuring method (see section 7.3 SELECTING THE MEASURING METHOD, page 56).
2. Prepare two standard calibration solutions.
3. Perform a two-point calibration according to user guidance.
4. The calibration record is displayed as soon as a stable value is achieved for the second standard calibration solution.

CALIBRATION		
ADA 94/IDS BNC		
B092500013		
01.09.2017 08:00		
#1 0.010 mg/l	358.1 mV	25.0 °C
#2 0.020 mg/l	374.4 mV	25.0 °C
Slp.: 54.1 mV		
Sensor +++ (Ion type: Ag)		
01.09.2017 08:00		

### Measurement

5. Start the measurement with **<F1>**/*[continue]*.  
An entry window appears.

Standard addition	
<b>i</b> Immerse sensor in sample	
Sample volume	100.0 ml
ISA/TISAB vol.	1.0 ml
continue	
01.09.2017 08:00	

6. Prepare the sample.
7. If necessary, add the ISA/TISAB solution to the sample.
8. Thoroughly rinse the electrode with deionized water.
9. Immerse the electrode in the sample.
10. Using **<▲>****<▼>** and **<ENTER>**, select the values for the volume of the sample (*Sample volume*) and the volume of the ISA/TISAB solution (*ISA/TISAB vol.*).

11. Select *continue* with  $\blacktriangle$  $\blacktriangledown$  and start the measurement with **<ENTER>**.  
When the measurement is finished an entry window appears.

12. Add the standard solution to the sample.
13. Using  $\blacktriangle$  $\blacktriangledown$  and **<ENTER>**, enter the values for the volume of the standard solution (*Std. volume*) and concentration of the standard solution (*Std. conc.*) .
14. Select *continue* with  $\blacktriangle$  $\blacktriangledown$  and start the measurement with **<ENTER>**.  
The measurement result is displayed when the measurement is completed.

15. If necessary, start measuring further samples with **<ENTER>**.  
Repeat steps 6 - 14 for all samples.
16. Terminate the measuring method with **<M>**.  
A safety query appears.
17. Select *yes* with  $\blacktriangle$  $\blacktriangledown$ .
18. Using **<ENTER>**, confirm *yes*.  
Measurement with the selected method is completed.

### 7.3.2 Standard subtraction

In the "Standard Subtraction" procedure, a known amount of standard solution is added to the sample (as complexing agent or precipitating agent) and, thus, the ion concentration lowered.

The ion concentration in the sample is calculated from the change in potential.

1. Select the measuring method (see section 7.3 SELECTING THE MEASURING METHOD, page 56).

#### Calibration

2. Prepare two standard calibration solutions.
3. Perform a two-point calibration according to user guidance.
4. The calibration record is displayed as soon as a stable value is achieved for the second standard calibration solution.

CALIBRATION		
ADA 94/IDS BNC		
B092500013		
01.09.2017 08:00		
#1 0.010 mg/l	358.1 mV	25.0 °C
#2 0.020 mg/l	374.4 mV	25.0 °C
Slp.: 54.1 mV		
Sensor +++ (Ion type: Ag)		
01.09.2017 08:00		

#### Measurement

5. Start the measurement with **<F1>**/*[continue]*. An entry window appears.

Standard subtraction	
<b>i</b> Immerse sensor in sample	
Sample volume	100.0 ml
ISA/TISAB vol.	1.0 ml
continue	
01.09.2017 08:00	

6. Prepare the sample.
7. If necessary, add the ISA/TISAB solution to the sample.
8. Thoroughly rinse the electrode with deionized water.

9. Immerse the electrode in the sample.
10. Using  $\blacktriangle$  $\blacktriangledown$  and  $\langle$ ENTER $\rangle$ , select the values for the volume of the sample (*Sample volume*) and the volume of the ISA/TISAB solution (*ISA/TISAB vol.*).
11. Select *continue* with  $\blacktriangle$  $\blacktriangledown$  and start the measurement with  $\langle$ ENTER $\rangle$ .  
When the measurement is finished an entry window appears.

12. Add the standard (complexing agent or precipitating agent) to the sample.
13. Using  $\blacktriangle$  $\blacktriangledown$  and  $\langle$ ENTER $\rangle$ , enter the values for the volume of the standard solution (*Std. volume*) and concentration of the standard solution (*Std. conc.*).
14. Using  $\blacktriangle$  $\blacktriangledown$  and  $\langle$ ENTER $\rangle$ , set the ion type for the ion in the standard (*Ion type*) if necessary.  
On selection of the ion type that can be defined (ION):  
Using  $\blacktriangle$  $\blacktriangledown$  and  $\langle$ ENTER $\rangle$ , set the valence (*Valency*) and molar weight (*Molar mass*) for the ion in the standard solution.
15. Select *continue* with  $\blacktriangle$  $\blacktriangledown$  and start the measurement with  $\langle$ ENTER $\rangle$ .  
The measurement result is displayed when the measurement is completed.

16. If necessary, start measuring further samples with  $\langle$ ENTER $\rangle$ .  
Repeat steps 6 - 15 for all samples.

17. Terminate the measuring method with **<M>**.  
A safety query appears.
18. Select yes with **<▲><▼>**.
19. Using **<ENTER>**, confirm yes.  
Measurement with the selected method is completed.

### 7.3.3 Sample addition

In the "Sample addition" procedure, a known amount of sample is added to the standard solution.

The ion concentration in the sample is calculated from the change in potential.

1. Select the measuring method (see section 7.3 SELECTING THE MEASURING METHOD, page 56).

### Calibration

2. Prepare two standard calibration solutions.
3. Perform a two-point calibration according to user guidance.
4. The calibration record is displayed as soon as a stable value is achieved for the second standard calibration solution.

CALIBRATION		
ADA 94/IDS BNC		
B092500013		
01.09.2017 08:00		
#1 0.010 mg/l	358.1 mV	25.0 °C
#2 0.020 mg/l	374.4 mV	25.0 °C
Slp.: 54.1 mV		
Sensor +++ (Ion type: Ag)		
01.09.2017 08:00		

### Measurement

5. Start the measurement with **<F1>**/*[continue]*.  
An entry window appears.

Sample addition	
<b>i</b> Immerse sensor in standard	
Std. volume	100.0 ml
Std. conc.	1.0 mg/l
ISA/TISAB vol.	1.0 ml
continue	
01.09.2017 08:00	

6. Prepare the standard solution.
7. If necessary, add the ISA/TISAB solution to the standard solution.
8. Thoroughly rinse the electrode with deionized water.
9. Immerse the electrode in the standard.
10. Using **<▲><▼>** and **<ENTER>**, enter the values for the volume of the standard solution (*Std. volume*), the concentration of the standard solution (*Std. conc.*) and the volume of the ISA/TISAB solution (*ISA/TISAB vol.*).
11. Select *continue* with **<▲><▼>** and start the measurement with **<ENTER>**.  
When the measurement is finished an entry window appears.

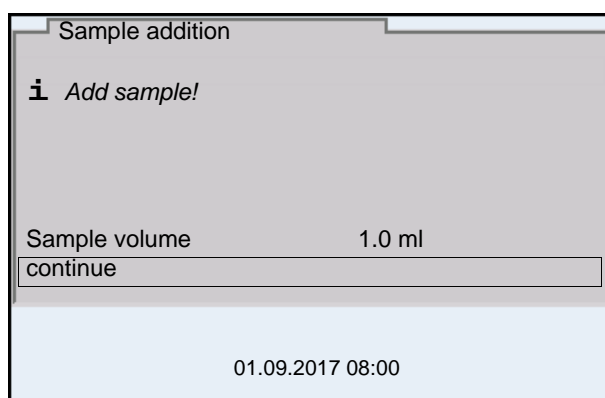

12. Add the sample to the standard solution.
13. Using **<▲><▼>** and **<ENTER>**, enter the value for the volume of the sample (*Sample volume*).
14. Select *continue* with **<▲><▼>** and start the measurement with **<ENTER>**.  
The measurement result is displayed when the measurement is completed.

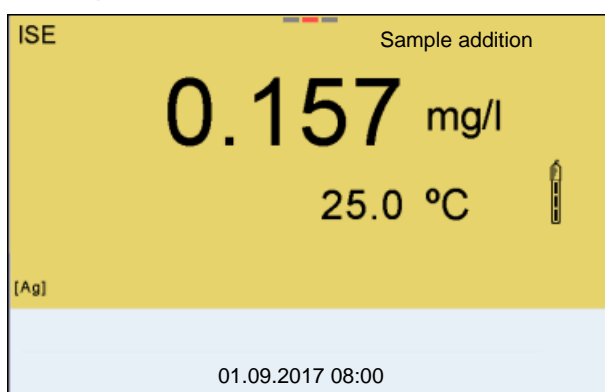

15. If necessary, start measuring further samples with **<ENTER>**.  
Repeat steps 6 - 14 for all samples.
16. Terminate the measuring method with **<M>**.  
A safety query appears.

17. Select yes with <▲><▼>.
18. Using <ENTER>, confirm yes.  
Measurement with the selected method is completed.

### 7.3.4 Sample subtraction

With the Sample subtraction procedure, a known amount of sample is added to the standard solution (complexing agent or precipitating agent).

The ion concentration in the sample is calculated from the change in potential. The sample subtraction is one method for the indirect determination of ions. It is used for the determination of ions for which no direct determination is possible.

1. Select the measuring method (see section 7.3 SELECTING THE MEASURING METHOD, page 56).  
An entry window appears.

2. Using <▲><▼> and <ENTER>, set the ion type for the ion in the standard (*Ion type*) as necessary.  
On selection of the ion type that can be defined (ION):  
Using <▲><▼> and <ENTER>, set the valency (*Valency*) and molar weight (*Molar mass*) for the ion in the standard solution.
3. Select and confirm *continue* with <▲><▼> and <ENTER>.

### Calibration

4. Prepare two standard calibration solutions.
5. Perform a two-point calibration according to user guidance.
6. The calibration record is displayed as soon as a stable value is achieved for the second standard calibration solution.

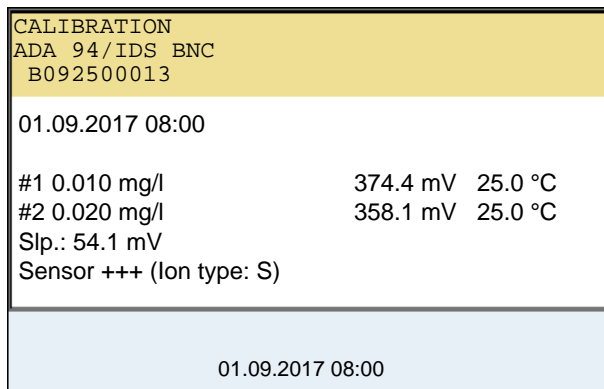

**Measurement**

7. Start the measurement with **<F1>** *continue*  
 An entry window appears.

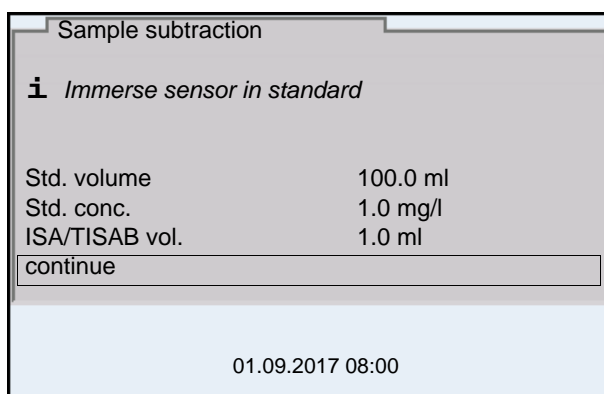

8. Prepare the standard solution.
9. If necessary, add the ISA/TISAB solution to the standard solution.
10. Thoroughly rinse the electrode with deionized water.
11. Immerse the electrode in the standard solution (complexing agent or precipitating agent).
12. Using **<▲><▼>** and **<ENTER>**, enter the values for the volume of the standard solution (*Std. volume*), the concentration of the standard solution (*Std. conc.*) and the volume of the ISA/TISAB solution (*ISA/TISAB vol.*).
13. Select *continue* with **<▲><▼>** and start the measurement with **<ENTER>**.  
 When the measurement is finished an entry window appears.



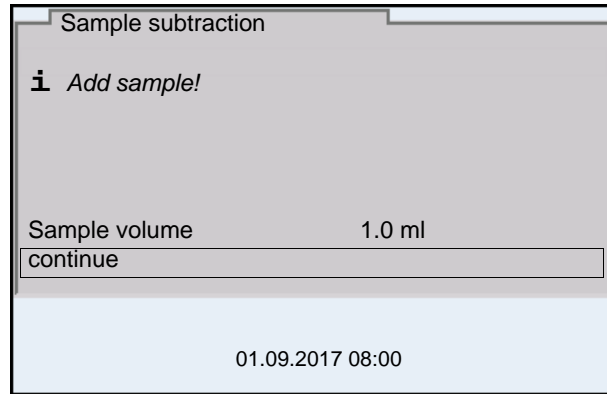

14. Add the sample to the standard (complexing agent or precipitating agent).
15. Using  $\blacktriangle$  and  $\blacktriangledown$  and  $\langle \text{ENTER} \rangle$ , enter the value for the volume of the sample (*Sample volume*).
16. Select *continue* with  $\blacktriangle$  and  $\blacktriangledown$  and start the measurement with  $\langle \text{ENTER} \rangle$ .  
The measurement result is displayed when the measurement is completed.

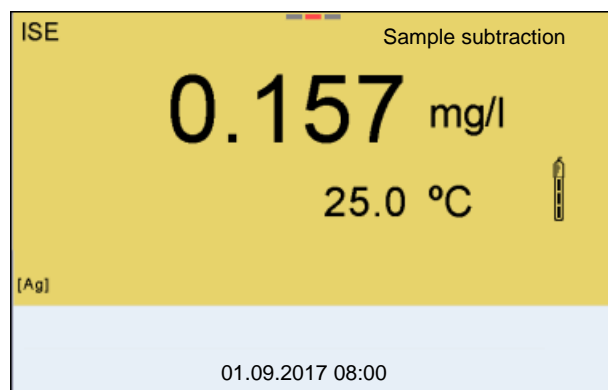

17. If necessary, start measuring further samples with  $\langle \text{ENTER} \rangle$ .  
Repeat steps 8 - 16 for all samples.
18. Terminate the measuring method with  $\langle \text{M} \rangle$ .  
A safety query appears.
19. Select yes with  $\blacktriangle$  and  $\blacktriangledown$ .
20. Using  $\langle \text{ENTER} \rangle$ , confirm yes.  
Measurement with the selected method is completed.

**7.3.5 Standard addition with blank value correction (*Blank value addition*)**

In the "Standard addition with blank value correction" procedure, a known amount of standard solution is added to the sample in two steps.

The ion concentration in the linear range of the electrode characteristic curve is increased with the first addition.

The second addition is equivalent to the standard addition. The ion concentration in the sample is calculated from the change in potential.

1. Select the measuring method (see section 7.3 SELECTING THE MEASURING METHOD, page 56).

**Calibration**

2. Prepare two standard calibration solutions.
3. Perform a two-point calibration according to user guidance.
4. The calibration record is displayed as soon as a stable value is achieved for the second standard calibration solution.

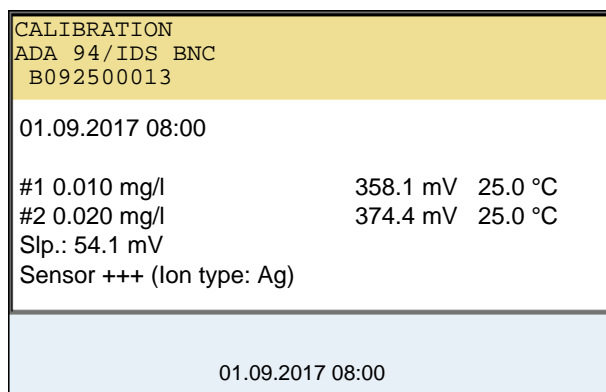

**Measurement**

5. Start the measurement with **<F1>** *continue*. An entry window appears.

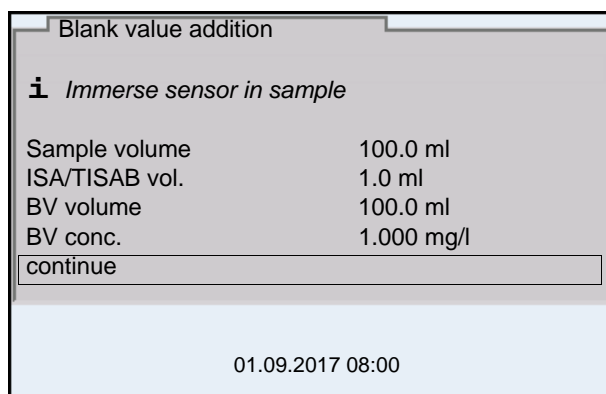

6. Prepare the sample.
7. If necessary, add the ISA/TISAB solution to the sample.
8. Thoroughly rinse the electrode with deionized water.

9. Immerse the electrode in the sample that was supplemented with blank value solution.
10. Using **<▲><▼>** and **<ENTER>**, enter the values for the volume of the sample (*Sample volume*), the volume of the ISA/TISAB solution (*ISA/TISAB vol.*), the volume of the blank value solution (*BV volume*) and the concentration of the blank value solution (*BV conc.*).
11. Select *continue* with **<▲><▼>** and start the measurement with **<ENTER>**.  
When the measurement is finished an entry window appears.

12. Add the standard solution to the sample.
13. Using **<▲><▼>** and **<ENTER>**, enter the values for the volume of the standard solution (*Std. volume*) and concentration of the standard solution (*Std. conc.*) .
14. Select *continue* with **<▲><▼>** and start the measurement with **<ENTER>**.  
The measurement result is displayed when the measurement is completed.

15. If necessary, start measuring further samples with **<ENTER>**.  
Repeat steps 6 - 12 for all samples.
16. Terminate the measuring method with **<M>**.  
A safety query appears.
17. Select *yes* with **<▲><▼>**.
18. Using **<ENTER>**, confirm *yes*.  
Measurement with the selected method is completed.

## 8 Dissolved oxygen

### 8.1 Measuring

#### 8.1.1 Measuring D.O.



The sensor connection and the USB-B (*USB Device*) interface are galvanically insulated. This facilitates interference-free measurements also in the following cases:

- Measurement in grounded test samples
- Measurement with several sensors connected to one MultiLab 4010-3W in one test sample

1. Connect the IDS-D.O. sensor to the meter. The D.O. measuring screen is displayed.
2. If necessary, select the measured parameter with **<M>**.
3. Check or calibrate the meter with the sensor.



Only in special cases does the FDO 4410-D.O. sensor require calibration. Regular FDO Checks are sufficient.

4. Immerse the D.O. sensor in the test sample.

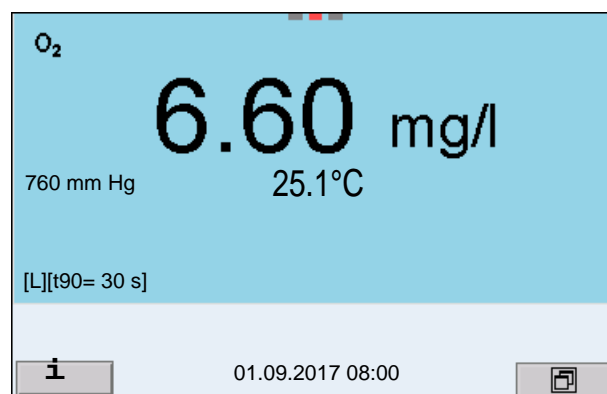

#### Selecting the displayed measured parameter

You can switch between the following displays with **<M>**:

- D.O. concentration [mg/l]
- D.O. saturation [%]

#### Salinity correction

When measuring the D.O. concentration [mg/l] of solutions with a salt content of more than 1 psu, a salinity correction is required. For this, you have to measure and input the salinity of the measured medium first.

When the salinity correction is switched on, the [Sal] indicator is displayed in the measuring screen.



You can switch the salinity correction on or off and enter the salinity in the menu for calibration and measurement settings (see section 10.4.1 SETTINGS FOR D.O. MEASUREMENT, page 104).

### Air pressure correction (*DO % Saturation local* function)

The integrated air pressure sensor of the MultiLab 4010-3W measures the current air pressure. During calibration, the air pressure correction function is automatically activated. While the parameter oxygen saturation [%] is displayed, the air pressure correction is applied if the *DO % Saturation local* function is active.

The current air pressure is shown on the display when an IDS oxygen sensor is connected.



The air pressure correction (function *DO % Saturation local*) is switched on or off in the menu for calibration and measurement settings (see section 10.4.3 DO % SATURATION LOCAL, page 106).

### Stability control (*AutoRead*) & HOLD function

The stability control function (*AutoRead*) continually checks the stability of the measurement signal. The stability has a considerable impact on the reproducibility of measured values.

The measured parameter flashes on the display

- as soon as the measured value is outside the stability range
- when the automatic *Stability control* is switched off.

Irrespective of the setting for automatic *Stability control* (see section 10.6.3 AUTOMATIC STABILITY CONTROL, page 110) in the *System* menu, you can start a measurement with *Stability control* manually at any time.

To start the *Stability control* function manually, the HOLD function must be enabled.

### Hold function

1. Freeze the measured value with **<AR>**.  
The [HOLD] status indicator is displayed.  
The HOLD function is active.



You can terminate the *Stability control* function and the HOLD function with **<AR>** or **<M>** at any time.

**Stability control**

2. Using **<ENTER>**, activate the *Stability control* function manually. The [AR] status indicator appears while the measured value is assessed as not stable. A progress bar is displayed and the display of the measured parameter flashes.  
As soon as a measured value meets the stability criteria, it is frozen. The [HOLD][AR] status indicator is displayed, the progress bar disappears, the display of the measured parameter stops flashing, and there is a beep.  
The current measurement data is output to the interface. Measurement data meeting the stability control criterion is marked by AR.



You can prematurely terminate the *Stability control* function manually with **<ENTER>** at any time. If the *Stability control* function is prematurely terminated, the current measurement data are output to the interfaces USB-B (*USB Device*, e.g. PC) and USB-A (*USB Host*, e.g. USB memory device or USB printer) without AutoRead info.

You can switch off the beep (see section 10.6 SENSOR-INDEPENDENT SETTINGS, page 109).

3. Using **<ENTER>**, start a further measurement with stability control.  
or  
Release the frozen measured value again with **<AR>** or **<M>**.  
The [AR] status display disappears. The display switches back to the previous indication.

**Criteria for a stable measured value**

The *Stability control* function checks whether the measured values are stable within the monitored time interval.

Measured parameter	Time interval	Stability in the time interval
D.O. concentration	20 seconds	$\Delta$ : better than 0.03 mg/l
D.O. saturation	20 seconds	$\Delta$ : better than 0.4 %
Temperature	15 seconds	$\Delta$ : better than 0.5 °C

The minimum duration until a measured value is assessed as stable is the monitored time interval. The actual duration is mostly longer.

**8.1.2 Measuring the temperature**

For reproducible D.O. measurements, it is essential to measure the temperature of the test sample.

IDS D.O. sensors measure the temperature with a temperature sensor integrated in the IDS sensor.

## 8.2 FDO Check (checking the FDO 4410)

The sensor is checked in water vapor-saturated air in the check and storage vessel FDO Check.

### 8.2.1 Why should you check the sensor?

With the FDO Check procedure you can find out in a simple manner whether the FDO 4410 D.O. sensor should be cleaned or calibrated.

### 8.2.2 When should you check the sensor?

Checking can be useful in the following cases:

- When the check interval has expired (the [check] status indicator is displayed).
- If the measured values seem to be implausible
- If you assume that the sensor cap is contaminated or at the end of its lifetime
- After the sensor cap was exchanged
- Routinely within the framework of the company quality assurance

### 8.2.3 Perform a FDO Check

Proceed as follows to carry out the FDO Check:

1. Connect the D.O. sensor to the meter.
2. Place the D.O. sensor in the FDO Check check and storage vessel.
3. Close the check and storage vessel FDO Check.



The sponge in the check and storage vessel must be moist (not wet). Leave the sensor in the check and storage vessel long enough so it can adapt to the ambient temperature (min. 15 minutes).

4. In the menu for measurement and calibration settings (<ENTER> / *FDO Check / Start FDO Check*), start the FDO Check. The meter switches to the display of %. During the *FDO Check* the *DO % Saturation local* function is automatically activated.

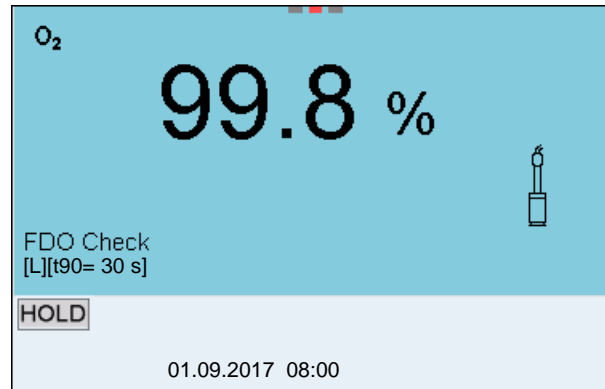

5. Start the measurement with **<ENTER>**.  
The measured value is checked for stability (stability control).  
The [AR] status indicator is displayed. The measured parameter flashes.
6. Wait for the end of the measurement with stability control (beep, [HOLD][AR] status indicator) or take over the calibrated value with **<ENTER>**.  
The measured value is frozen.
7. Switch to the measured value display with **<M>**.  
The check measurement is not documented.  
After the *FDO Check* the *DO % Saturation local* function is automatically reset to the setting before the *FDO Check*.

#### 8.2.4 Evaluation

The evaluation is based on the accuracy required and defined by the user (e.g.  $\pm 2\%$ ). Together with the nominal value (100 %) this results in a validity scope (98 to 102 %) for the check (see example).

If the measured value is within the validity scope, no cleaning or user calibration is required.

If the measured value is outside the validity scope, the sensor shaft and membrane should be cleaned, and the check should then be repeated (see section 8.2.3 PERFORM A FDO CHECK, page 71).

#### Example:

- Required accuracy:  $\pm 2\%$ .
- In water vapor-saturated air or in air-saturated water, the nominal value is 100 % (while taking into account the local air pressure).
- Therefore, the validity scope is 98 ... 102 %
- The check resulted in a measured value of 99.3 %

The measurement error is within the specified validity scope.  
No cleaning or user calibration is required.



## 8.3 Calibration

### 8.3.1 Why calibrate?

D.O. sensors age. Aging changes the zero point and slope of the D.O. sensor. As a result, an inexact measured value is displayed. Calibration determines and stores the current values of the zero point and slope.



The FDO 4410 D.O. sensor ages so little it does not have to be regularly calibrated.

To detect changes of the sensor as early as possible, the FDO Check procedure can be useful (see section 8.2 FDO CHECK (CHECKING THE FDO 4410), page 71).

### 8.3.2 When to calibrate?

- If your evaluation of the FDO Check suggests calibrating (only FDO 4410)
- When the calibration interval has expired
- When your accuracy requirements are especially high
- Routinely within the framework of the company quality assurance
- After a *Zero Calibration*.

### 8.3.3 Calibration procedures

The MultiLab 4010-3W provides 2 calibration procedures:

- Calibration in water vapor-saturated air.
- Calibration via a comparison measurement (e.g. Winkler titration according to DIN EN 25813 or ISO 5813). At the same time, the relative slope is adapted to the comparison measurement by a correction factor. When the correction multiplier is active, the [*Factor*] indicator appears in the measuring window.



For both calibration procedures, an additional *Zero Calibration* is possible (see section 8.3.6 ZERO CALIBRATION, page 76).

### 8.3.4 Calibration in water vapor-saturated air

For this calibration procedure, the *Comparison meas.* setting must be set to *off* in the *Calibration* menu.

As the calibration vessel use a BOD bottle that contains a small amount of clean water (approx. 40 ml). The sensor must not be immersed in the water.



To calibrate the FDO 4410, use the calibration and storage vessel FDO Check. The sponge in the check and storage vessel must be moist (not wet).

Proceed as follows to calibrate the D.O. sensor:

1. Connect the D.O. sensor to the meter.
2. Put the D.O. sensor into the calibration vessel.
3. For FDO 4410 with the check and storage vessel FDO Check: Close the check and storage vessel FDO Check.



Leave the sensor in the calibration vessel or check and storage vessel (FDO 4410) long enough (at least 15 minutes) until the air is saturated with water vapor and the sensor has adapted to the ambient temperature.

4. Start the calibration with **<CAL>**.

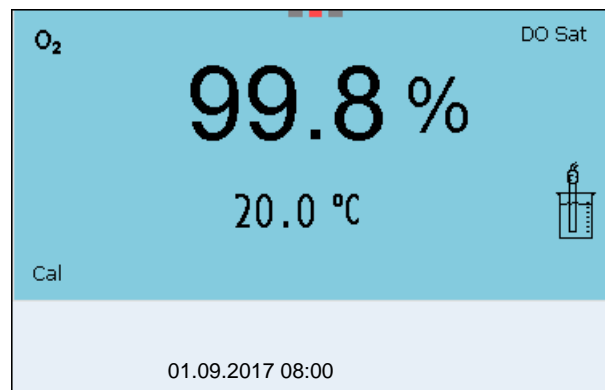

5. Start the measurement with **<ENTER>**.  
The measured value is checked for stability (stability control).  
The [AR] status indicator is displayed. The measured parameter flashes.
6. Wait for the measurement with stability control to be finished (beep, [HOLD][AR] status indicator).  
The calibration record is displayed and output to the interface.
7. Switch to the measured value display with **<ENTER>**.

### 8.3.5 Calibrating with *Comparison meas.* (e.g. Winkler titration)

With the calibration procedure *Comparison meas.*, the measured value of the sensor is adjusted to the nominal value of a comparison solution via a correc-

tion factor. The current correction factor is documented in the sensor menu (**i** *Factor* = x.xxx) and in the calibration record.

For this calibration procedure, the *Comparison meas.* setting must be set to *on* in the *Calibration* menu.

Proceed as follows to calibrate the D.O. sensor:

1. Connect the D.O. sensor to the meter.
2. Immerse the D.O. sensor in the reference solution.
3. Start the calibration with **<CAL>**.

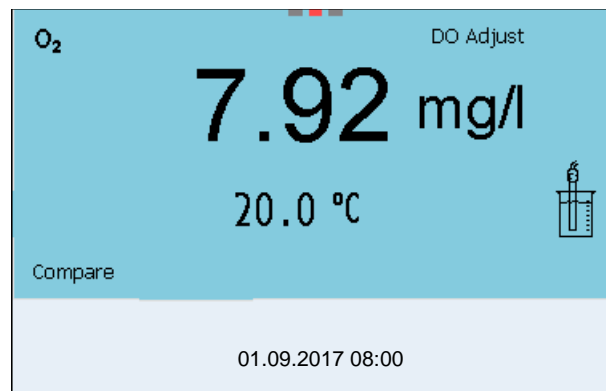

4. Start the measurement with **<ENTER>**.  
The measured value is checked for stability (stability control).  
The [AR] status indicator is displayed. The measured parameter flashes.
5. Wait for the measurement with stability control to be finished (beep, [HOLD][AR] status indicator).

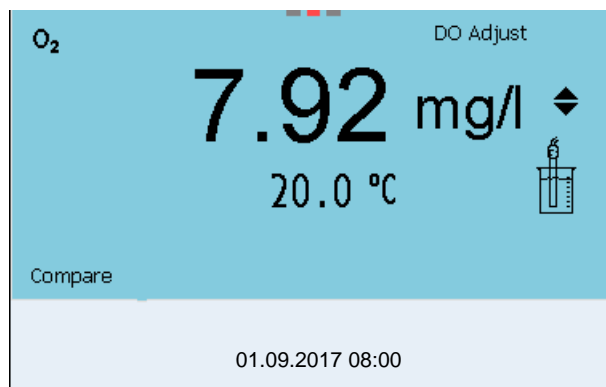

- Using  $\langle \blacktriangle \rangle \langle \blacktriangledown \rangle$ , set the correction factor to adjust the displayed value to the nominal value (value of the comparison measurement). Subsequently take over the adjustment with  $\langle \text{ENTER} \rangle$ .  
The meter switches to the measured value display.  
The status display [*Factor*] is active.

### 8.3.6 Zero Calibration

With a *Zero Calibration*, the zero point of the sensor is redetermined by calibrating in a zero solution.

For most applications, an additional *Zero Calibration* is not required and not recommended. Only with very rare applications can the accuracy of a calibration be improved if a *Zero Calibration* was carried out before.



The FDO 4410 D.O. sensor ages so little it does not have to be zero point calibrated.

A zero point calibration is not allowed for this sensor.

The *Zero Calibration* is best carried out prior to calibrating with a calibration procedure (e.g. calibration in water vapor-saturated air or calibration with comparison measurement).

- Connect the D.O. sensor to the meter.
- Place the D.O. sensor in a solution that does not contain any dissolved oxygen.



A solution not containing any dissolved oxygen can be prepared by dissolving approx. 8 to 10 g sodium sulfite ( $\text{Na}_2\text{SO}_3$ ) in 500 ml tap-water. Carefully mix the solution. It may take up to 60 minutes until the solution is free of oxygen.

- In the menu for measurement and calibration settings ( $\langle \text{ENTER} \rangle$  / *Calibration* / *Zero Calibration*), start the *Zero Calibration*.  
The calibration point for the measured value 0 (DO Zero) is displayed.

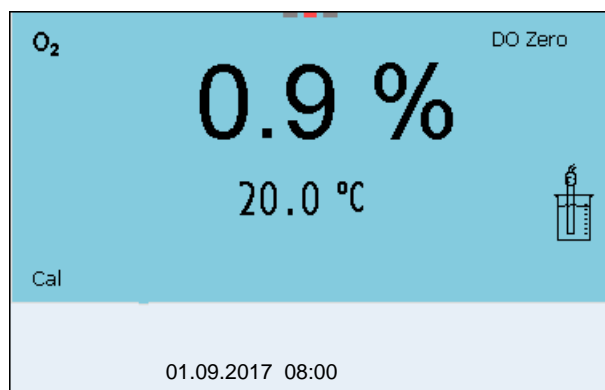

4. Start the measurement with **<ENTER>**.  
The measured value is checked for stability (stability control).  
The [AR] status indicator is displayed. The measured parameter flashes.
5. Wait for the measurement with stability control to be finished (beep, [HOLD][AR] status indicator).  
The current value is set to zero.  
The calibration record is displayed.
6. Switch to the measured value display with **<F1>**/[continue].  
The zero point is calibrated.  
The [ZeroCal] status indicator is displayed.
7. Carry out a calibration (see section 8.3.3 CALIBRATION PROCEDURES, page 73).

### 8.3.7 Calibration data



The calibration record is automatically transmitted to the interface after calibrating.

The calibration record of the last calibration is available in the menu *Calibration / Calibration record*. To open it in the measured value display, press the **<CAL\_>** key.

The calibration records of the last 10 calibrations are available in the menu *Calibration / Calibration data storage*. To open the *Calibration* menu in the measured value display, press the **<ENTER>** key.

Menu item	Setting/function	Explanation
<i>Calibration / Calibration data storage / Display</i>	-	Displays the calibration records. Further options: <ul style="list-style-type: none"> <li>● Scroll through the calibration records with &lt;&lt;◀&gt;◀▶&gt;.</li> <li>● Using &lt;PRT&gt;, output the displayed calibration record to the interface USB-B (<i>USB Device</i>, e.g. PC) or USB-A (<i>USB Host</i>, e.g. USB printer).</li> <li>● Using &lt;PRT_&gt;, output all calibration records to the interface USB-B (<i>USB Device</i>, e.g. PC) or USB-A (<i>USB Host</i>, e.g. USB printer).</li> <li>● Quit the display with &lt;ESC&gt;.</li> <li>● Switch directly to the measured value display with &lt;M&gt;.</li> </ul>
<i>Calibration / Calibration data storage / Output to USB flash drive or printer</i>	-	Outputs the stored calibration data to the USB-A interface ( <i>USB Host</i> , e.g. USB memory device/USB printer) (see section 12 TRANSMITTING DATA, page 120).
<i>Calibration / Calibration data storage / Output to RS232/USB</i>	-	Outputs the stored calibration data to the USB-B interface ( <i>USB Device</i> , e.g. PC) (see section 12 TRANSMITTING DATA, page 120).

### Calibration evaluation

After calibration, the meter automatically evaluates the current status of the calibration. The evaluation appears on the display and in the calibration record.





For evaluation, the characteristic curve of the sensor that was determined is compared to the characteristic curve of an ideal sensor at similar environmental conditions (relative slope S):

$$S = S_{\text{sensor}} / S_{\text{ideal sensor}}$$

An ideal sensor has a slope of 1.

**Calibration  
evaluation FDO 4410**

Display	Calibration record	Relative slope
	+++	S = 0.94 ... 1.06
	++	S = 0.92 ... 0.94 or S = 1.06 ... 1.08
	+	S = 0.90 ... 0.92 or S = 1.08 ... 1.10
<i>Error</i> Error elimination (see section 14 WHAT TO DO IF..., page 128)	<i>Error</i>	S < 0.90 or S > 1.10

**Calibration  
evaluation  
ProOBOD,  
4100 ProBOD,  
YSI 5010 with 4011  
Adapter**

Display	Calibration record
	+++
Error elimination (see section 14 WHAT TO DO IF..., page 128)	

**Calibration protocol  
(example FDO 4410)**

```

CALIBRATION Ox
01.09.2017 07:43:33

FDO 4410
Ser. no. 12B100016

SC-FDO           12B100015
Sensor           +++

```

## 8.4 Measuring with methods

### 8.4.1 General information

The methods for the calculation of OUR and SOUR values simplify compliance with US EPA 40 CFR Part 503 regulations and provide useful tools for plant operating.

**Methods** The following methods are supported:

- *OUR* (Oxygen Uptake Rate)
- *SOUR* (Specific Oxygen Uptake Rate)

**Sensors** Suitable oxygen sensors for measuring with methods:

- ProOBOD
- 4100 ProBOD
- 5010press 4011 Adapter

### Formula to calculate the values

$$OUR = \frac{DO_{START} - DO_{END}}{T_{TEST}} \cdot \frac{3600 \text{ sec}}{1 \text{ h}} \cdot \frac{V_{total}}{V_{sample}}$$

$$SOUR = \frac{OUR}{\beta_{solids}}$$

$$SOUR_{20} = SOUR_T \times \theta^{(20-T)} \quad \begin{array}{l} \theta = 1.05 \text{ (} T > 20 \text{ }^\circ\text{C)} \\ \theta = 1.07 \text{ (} T < 20 \text{ }^\circ\text{C)} \end{array}$$

*OUR*      Oxygen Uptake Rate (mg O<sub>2</sub> /L/h)

*SOUR*      Specific Oxygen Uptake Rate (mg O<sub>2</sub> /h/g)

*SOUR*<sub>20</sub>      SOUR value at reference temperature 20 °C  
(temperature correction according to Farrell and Bhide equation)

*DO*<sub>END</sub>      Oxygen concentration at the end of the measurement (mg/L)

*DO*<sub>START</sub>      Oxygen concentration at the start of the measurement (mg/L)

*T*<sub>TEST</sub>      Total duration of the measurement (s)

*V*<sub>total</sub>      Volume of the test sample  
(sum of sample volume and dilution water)

*V*<sub>sample</sub>      Volume of the test sample

*β*<sub>solids</sub>      Total Suspended Solids concentration in the test sample (g/L)

#### 8.4.2 Selecting and starting the measuring method

1. Connect a suitable oxygen sensor to the meter.  
The D.O. measuring screen is displayed.
2. If necessary, select the measured parameter with **<M>**.
3. Check or calibrate the meter with the sensor.
4. Open the oxygen menu with **<ENTER>**.
5. Select *Method* with **<▲><▼>** and confirm with **<ENTER>**.
6. Select a method with **<▲><▼>** and confirm with **<ENTER>**.



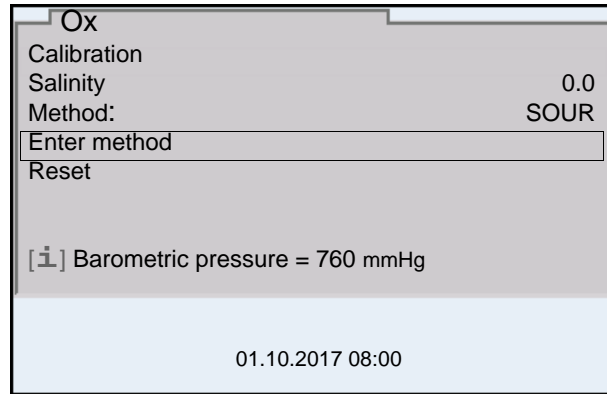

7. Select *Enter method* with  $\langle \blacktriangle \rangle \langle \blacktriangledown \rangle$  and confirm with  $\langle \text{ENTER} \rangle$ . The start window for the method is displayed. (see section 8.4.4 OUR (OXYGEN UPTAKE RATE), page 82... section 8.4.5 SOUR (SPECIFIC OXYGEN UPTAKE RATE), page 84).

### 8.4.3 Editing the setting for the measuring method

The settings for the selected method can be edited before or after measuring.

1. Select and start the measuring method (see section 8.4.2 SELECTING AND STARTING THE MEASURING METHOD, page 80).
2. Open the settings for the method with  $\langle \text{ENTER} \rangle$ .



Scroll to further menu items with  $\langle \blacktriangle \rangle \langle \blacktriangledown \rangle$  as necessary.

Settings	Menu item	Possible setting	Explanation
	<i>Sample / Total (1 / n)</i>	1 ... 100	Enter the ratio of the sample volume (1) to total volume (n) of the test sample (Example: 1 part sample is diluted with 9 parts water. The ratio of sample volume to total volume is 1/10; n = 10.)
	<i>Minimum time</i>	1 ... 60 min	Set the minimum time for the measuring duration (in minutes)
	<i>Maximum time</i>	1 ... 15 ... 60 min	Set the maximum time for the measuring duration (in minutes). When the maximum time has expired the measurement will end automatically.
	<i>Min. beginning DO</i>	0 ... 5 ... 70 mg/l	If the value is below the specified limiting value, the method is not started.

Menu item	Possible setting	Explanation
<i>Min. ending DO</i>	0 ... <b>2</b> ... 70 mg/l	If the value is below the specified limiting value, the method ends automatically.
<i>Solids weight (only for SOUR)</i>	0 ... <b>1.000</b> ...32.000 g/l	Enter the concentration of Total Suspended Solid in the test sample
<i>Temperature correction (only for SOUR)</i>	<b>20°C</b> off	Enable or disable the conversion of the measured values to the reference temperature 20 °C.
<i>Reset</i>	-	Resets the settings of the method to the default values.
<i>Stop method</i>		Quits the method. The settings are retained.

- Quit the settings for the method with **<ESC>**.  
The start window for the method is displayed.

#### 8.4.4 OUR (Oxygen Uptake Rate)

- Select and start the measuring method (see section 8.4.2 SELECTING AND STARTING THE MEASURING METHOD, page 80).  
The start window for the method is displayed.
- Adjust the settings with **<ENTER>** as necessary (see section 8.4.3 EDITING THE SETTING FOR THE MEASURING METHOD, page 81).

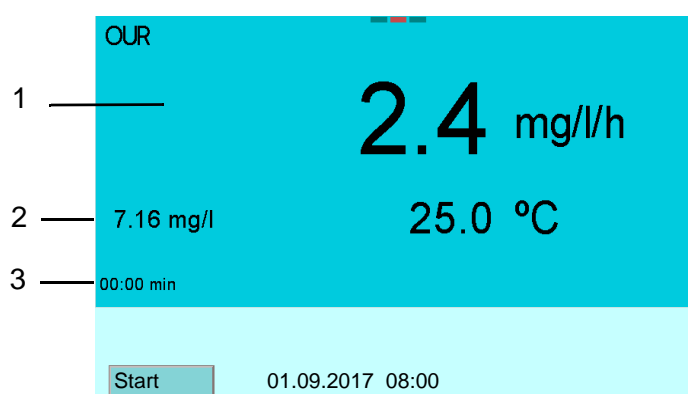

- Measured value, OUR (mg/l/h)
- Measured value, Concentration [mg/l]
- Expired time (min)

#### Measuring

- Start measuring with **<F1>**/**[Start]**.

- Wait until the method ends automatically (e.g. when the specified maximum time has expired, or the specified limiting value for the concentration is reached).

While the method is active, the current measurement dataset will be automatically sent to the USB-B interface every 15 seconds.

### Output during measurement

```
Device;Device serial;ID;Date/Time;Value;Unit;Mode;Value2;Unit2;Mode2;Measurement;Calibration;Additional;Sensor;Sensor serial
4010-3W; 17310964;;06.13.2018 11:34:31; --- ;mg/l/h;OUR; 7.54;mg/l;Ox;N/A;N/A; 23.7 °C;YSI 4011 Adapter;17371097;
4010-3W; 17310964;;06.13.2018 11:34:46;1.00;mg/l/h;OUR; 7.54;mg/l;Ox;N/A;N/A; 23.7 °C;YSI 4011 Adapter;17371097;
4010-3W; 17310964;;06.13.2018 11:35:01;1.15;mg/l/h;OUR; 7.53;mg/l;Ox;N/A;N/A; 23.7 °C;YSI 4011 Adapter;17371097;
4010-3W; 17310964;;06.13.2018 11:35:16;1.04;mg/l/h;OUR; 7.53;mg/l;Ox;N/A;N/A; 23.7 °C;YSI 4011 Adapter;17371097;
etc...
```



You can quit the method prematurely at any time with **<F1>/[Stop]**. The data saved up to this time will then be retained.

You can cancel the method at any time with **<M>**. The data saved up to this time will then be lost.

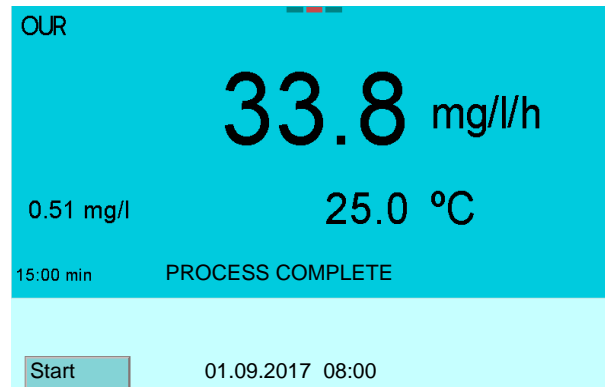

- Adjust the settings with **<ENTER>** as necessary (see section 8.4.3 EDITING THE SETTING FOR THE MEASURING METHOD, page 81).

### Editing and saving the measurement data

- Open the measurement data display for saving and editing with **<STO>**. The measurement data are graphically displayed on the screen.

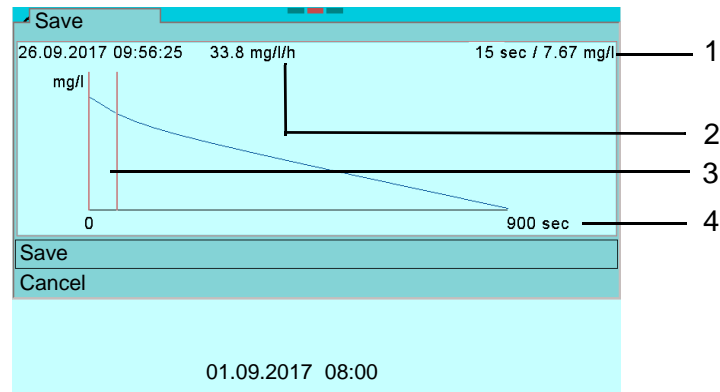

- 1 Measured value, Concentration (mg/l), at reference time (4)
- 2 Measured value, OUR (mg/l/h), at reference time
- 3 Reference time (sec)
- 4 Test time (sec)

7. Press **<◀><▶>** to select the reference point on the time axis with which the measurement should be saved.  
Only data between the reference time and the end point of the measurement are used to calculate the OUR value.
8. Press **<▲><▼>** to select Save and **<ENTER>** to confirm.  
The measurement data are saved.
9. Edit the settings for the method with **<ENTER>**.  
or  
Save the measurement data again with **<STO>**.  
or  
Output the record to the interface with **<PRT>**.  
or  
Start a new measurement with **<F1>/[Start]**.  
or  
Quit the method with **<M>**.

#### 8.4.5 SOUR (Specific Oxygen Uptake Rate)

1. Select and start the measuring method (see section 8.4.2 SELECTING AND STARTING THE MEASURING METHOD, page 80).  
The start window for the method is displayed.
2. Adjust the settings with **<ENTER>** as necessary (see section 8.4.3 EDITING THE SETTING FOR THE MEASURING METHOD, page 81).

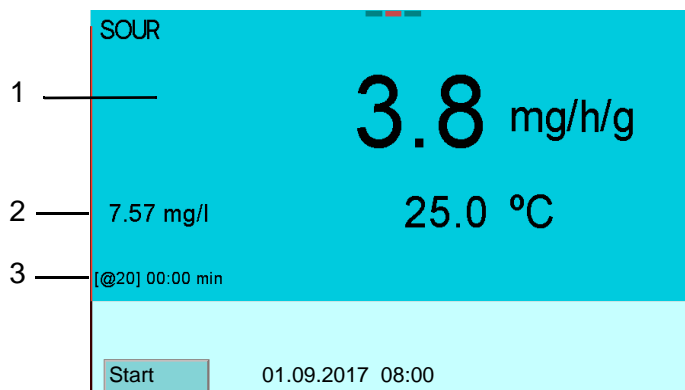

- 1 Measured value, SOUR (mg/h/g)
- 2 Measured value, Concentration [mg/l]
- 3 [Reference temperature] Time expired (min)

### Measuring

3. Start measuring with **<F1>/[Start]**.
4. Wait until the method ends automatically (e.g. when the specified maximum time has expired, or the specified limiting value for the concentration is reached).  
While the method is active, the current measurement dataset will be automatically sent to the USB-B interface every 15 seconds.

### Output during measurement

```
Device;Device serial;ID;Date/Time;Value;Unit;Mode;Value2;Unit2;Mode2;Measurement;Calibration;Additional;Sensor;Sensor serial
4010-3W;17310964;;06.13.2018 11:29:30; --- ;mg/h/g;SOUR;7,66;mg/l;Ox;N/A;N/A;23.7 °C;YSI 4011 Adapter;17371097
4010-3W;17310964;;06.13.2018 11:29:45;1,32;mg/h/g;SOUR;7,65;mg/l;Ox;N/A;N/A;23.7 °C;YSI 4011 Adapter;17371097
4010-3W;17310964;;06.13.2018 11:30:00;1,38;mg/h/g;SOUR;7,64;mg/l;Ox;N/A;N/A;23.7 °C;YSI 4011 Adapter;17371097
4010-3W;17310964;;06.13.2018 11:30:15;1,59;mg/h/g;SOUR;7,63;mg/l;Ox;N/A;N/A;23.7 °C;YSI 4011 Adapter;17371097
4010-3W;17310964;;06.13.2018 11:30:30;1,67;mg/h/g;SOUR;7,62;mg/l;Ox;N/A;N/A;23.7 °C;YSI 4011 Adapter;17371097
etc...
```



You can quit the method prematurely at any time with **<F1>/[Stop]**. The data saved up to this time will then be retained.

You can cancel the method at any time with **<M>**. The data saved up to this time will then be lost.



### Editing and saving the measurement data

5. Adjust the settings with **<ENTER>** as necessary (see section 8.4.3 EDITING THE SETTING FOR THE MEASURING METHOD, page 81).
6. Open the measurement data display for saving and editing with **<STO>**.  
The measurement data are graphically displayed on the screen.

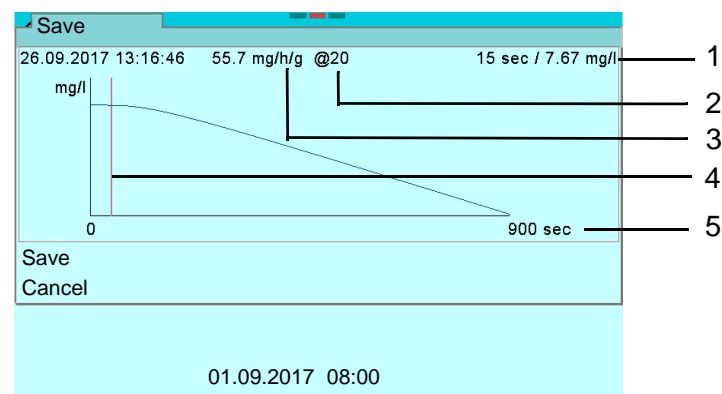

- 1 Measured value, Concentration (mg/l), at reference time (4)
  - 2 Reference temperature (° C)
  - 3 Measured value, SOUR (mg/h/g), at reference time
  - 4 Reference time (sec)
  - 5 Test time (sec)
7. Press **<◀><▶>** to select the optimum reference point on the time axis with which the measurement should be saved.  
Only data between the reference time and the end point of the measurement are used to calculate the SOUR value.
  8. Press **<▲><▼>** to select Save and **<ENTER>** to confirm.  
The measurement data are saved.

9. Edit the settings for the method with **<ENTER>**.  
or  
Save the measurement data with **<STO>**.  
or  
Output the record to the interface with **<PRT>**.  
or  
Start a new measurement with **<F1>**/[Start].  
or  
Quit the method with **<M>**.

#### 8.4.6 Measurement data storage for *OUR/SOUR* measurements

Measurement data determined with the methods *OUR* or *SOUR* are saved as graphics to a separate storage.

20 datasets are stored of measurements with the methods *OUR* or *SOUR*.

#### If the storage is full

The oldest dataset is automatically overwritten.

#### Opening the measurement data storage

You can open the measurement data storage for *OUR/SOUR* in the following ways:

- From any measurement display via **<ENTER\_>** (*Storage & config*)/ *Data storage / OUR/SOUR* data storage.
- From the measurement display for a method via **<RCL>**.

#### Managing the measurement data storage

The management of the measurement data storage is done like that for all measurement data memories (see section 11 DATA STORAGE, page 114).

#### Display presentation of a dataset

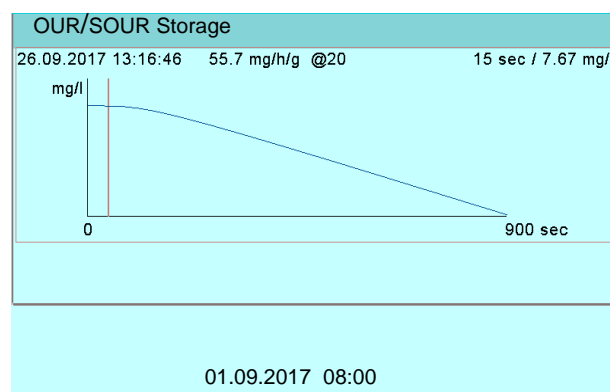

1. Select a different dataset with **<<><>>**.  
or  
Output the record to the interface with **<PRT>**.

**Output from storage  
(e.g. SOUR record)**

```
01.09.2017 09:56:20
4010-3W
Ser. no. 09250023

4100 ProBOD
Ser. no. B092500013

Reference point: 105 sec
sec          mg/l
0            8.52
15           7.28
30           6.98
45           6.80
60           6.66
75           6.53 . . .
863         1.99
SOUR = 26.04 mg/h/g
SOUR@20 = 20.07 mg/h/g Tavg = 25.34 C
Dilution ratio: 1 / 2(Sample/Total)
Solids Weight: 1.000 g/L

-----

etc...
```

**Quitting the display**

To quit the display of stored measurement datasets, you have the following options:

- Switch directly to the measured value display with **<M>**.
- Quit the display and move to the next higher menu level with **<ESC>**.

**Erasing the  
measurement data  
storage**

How to erase the measured value storage is described in section 11.3.1 MANAGING THE MEASUREMENT DATA STORAGE, page 117.



## 9 Conductivity

### 9.1 Measuring

#### 9.1.1 Measuring the conductivity



The sensor connection and the USB-B (*USB Device*) interface are galvanically insulated. This facilitates interference-free measurements also in the following cases:

- Measurement in grounded test samples
- Measurement with several sensors connected to one MultiLab 4010-3W in one test sample

1. Connect the conductivity sensor to the meter. The conductivity measuring window is displayed. The measuring cell and cell constant for the connected IDS conductivity sensor are automatically taken over.
2. If necessary, press **<M>** to select the measured parameter  $\chi$ .
3. Immerse the conductivity sensor in the test sample.

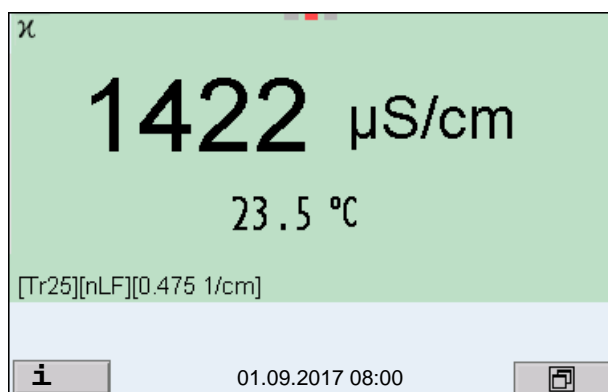

**Selecting the displayed measured parameter**

You can switch between the following displays with **<M>**:

- Conductivity [ $\mu\text{S}/\text{cm}$ ] / [ $\text{mS}/\text{cm}$ ]
- Resistivity [ $\Omega\cdot\text{cm}$ ] / [ $\text{k}\Omega\cdot\text{cm}$ ] / [ $\text{M}\Omega\cdot\text{cm}$ ]
- Salinity Sal [ ] (  $\triangle$  psu)
- Total dissolved solids TDS [ $\text{mg}/\text{l}$ ] / [ $\text{g}/\text{l}$ ]

The factor to calculate the total dissolved solids is set to 1.00 in the factory. You can adjust this factor to meet your requirements in the range 0.40 ... 1.00. The factor is set in the menu for the parameter TDS (**<ENTER>** / *Multiplier for TDS*).



Determining the TDS multiplier:

See section 19.3 CALCULATE THE TDS MULTIPLIER, page 150.

### Stability control (AutoRead) & HOLD function

The stability control function (*AutoRead*) continually checks the stability of the measurement signal. The stability has a considerable impact on the reproducibility of measured values.

The measured parameter flashes on the display

- as soon as the measured value is outside the stability range
- when the automatic *Stability control* is switched off.

You can start the *Stability control* manually at any time, irrespective of the setting for automatic *Stability control* (see section 10.6.3 AUTOMATIC STABILITY CONTROL, page 110) in the *System* menu.

To start the *Stability control* function manually, the HOLD function must be enabled.

### Hold function

1. Freeze the measured value with **<AR>**.  
The [HOLD] status indicator is displayed.  
The HOLD function is active.



You can terminate the *Stability control* function and the HOLD function with **<AR>** or **<M>** at any time.

### Stability control

2. Using **<ENTER>**, activate the *Stability control* function manually. The [AR] status indicator appears while the measured value is assessed as not stable. A progress bar is displayed and the display of the measured parameter flashes.  
As soon as a measured value meets the stability criteria, it is frozen. The [HOLD][AR] status indicator is displayed, the progress bar disappears and the display of the measured parameter stops flashing.  
The current measurement data is output to the interface. Measurement data meeting the stability control criterion is marked by AR.



You can prematurely terminate the *Stability control* function manually with **<ENTER>** at any time. If the *Stability control* function is prematurely terminated, the current measurement data are output to the interfaces USB-B (*USB Device*, e.g. PC) and USB-A (*USB Host*, e.g. USB memory device or USB printer) without AutoRead info.

You can switch off the beep (see section 10.6 SENSOR-INDEPENDENT SETTINGS, page 109).

3. Using **<ENTER>**, start a further measurement with stability control.  
or  
Release the frozen measured value again with **<AR>** or **<M>**.  
The [AR] status display disappears. The display switches back to the previous indication.

**Criteria for a stable measured value**

The *Stability control* function checks whether the measured values are stable within the monitored time interval.

Measured parameter	Time interval	Stability in the time interval
Conductivity $\kappa$	10 seconds	$\Delta \kappa$ : better than 1.0% of measured value
Temperature	15 seconds	$\Delta$ : better than 0.5 °C

The minimum duration until a measured value is assessed as stable is the monitored time interval. The actual duration is mostly longer.

**9.1.2 Measuring the temperature**

For reproducible conductivity measurements, it is essential to measure the temperature of the test sample.

IDS sensors measure the temperature with a temperature sensor integrated in the IDS sensor.

**9.2 Temperature compensation**

The calculation of the temperature compensation is based on the preset reference temperature, 20 °C or 25 °C. It appears on the display as *Tr20* or *Tr25*.

You can select one of the following temperature compensation methods:

- **Nonlinear temperature compensation (*nLF*)** according to ISO 7888
- **Linear temperature compensation (*Lin*)** with adjustable coefficient
- **No temperature compensation (off)**



The reference temperature and temperature compensation are set in the menu for the parameter, conductivity (see section 10.5.1 SETTINGS FOR IDS CONDUCTIVITY SENSORS, page 106).

**Application tips**

Select the following temperature compensations given in the table according to the respective test sample:

Test sample	Temperature compensation	Display
Natural water (ground water, surface water, drinking water)	<i>nLF</i> according to ISO 7888	<i>nLF</i>
Ultrapure water	<i>nLF</i> according to ISO 7888	<i>nLF</i>

Test sample	Temperature compensation	Display
Other aqueous solutions	<i>lin</i> Set linear temperature coefficient 0.000 ... 10.000 %/K	<i>lin</i>
Salinity (seawater)	Automatic <i>nLF</i> according to IOT (International Oceanographic Tables)	<i>Sal, nLF</i>

### 9.3 Calibration

#### 9.3.1 Why calibrate?

Aging slightly changes the cell constant, e.g. due to coatings. As a result, an inexact measured value is displayed. The original characteristics of the cell can often be restored by cleaning the cell. Calibration determines the current value of the cell constant and stores this value in the meter.

Thus, you should calibrate at regular intervals.

#### 9.3.2 When to calibrate?

- Routinely within the framework of the company quality assurance
- When the calibration interval has expired

#### 9.3.3 Calibration procedure

The MultiLab 4010-3W provides 2 calibration procedures:

- Determining the cell constant  
Calibration in the check- and calibration standard 0.01 mol/l KCl (1413  $\mu\text{S}/\text{cm}$  @25 °C)  
Safe and simple calibration procedure for IDS conductivity sensors with a cell constant in the range 0.450 ... 0.500  $\text{cm}^{-1}$ .
- Determining the cell constant  
Calibration with freely selectable check- and calibration standard  
Comprehensive and flexible calibration procedure for all IDS conductivity sensors, irrespective of the cell constant.

Which calibration procedures can be used depends on the conductivity sensor used. The menu for measurement settings automatically displays only those settings and calibration procedures that are available for the sensor.



With conductivity sensors for which a cell constant was set, no sensor symbol appears on the display.  
If a calibration interval was specified, it is not active.

### 9.3.4 Determining the cell constant (calibration in the check- and calibration standard)

For this calibration procedure, IDS conductivity sensors with a cell constant in the range 0.450 ... 0.500 cm<sup>-1</sup> are suitable, e.g. 4310.

IDS conductivity sensors with other cell constants are unsuitable for this simple calibration procedure. As an alternative, you can manually determine the cell constant and adjust it in the menu (see section 9.3.5 SETTING THE CELL CONSTANT (CALIBRATION WITH FREELY SELECTABLE CHECK- AND CALIBRATION STANDARD), page 94).

You can determine the actual cell constant of the IDS conductivity sensor within a valid range (e.g. 4310: 0.450 ... 0.500 cm<sup>-1</sup>).

The cell constant is determined in the check- and calibration standard 0.01 mol/l KCl (1413 µS/cm @ 25 °C).

In the default condition, the calibrated cell constant is set to the nominal cell constant of the IDS sensor (e.g. 4310: 0.475 cm<sup>-1</sup>).

For this calibration procedure, the *Type* setting must be set to *cal*. Proceed as follows to determine the cell constant:

1. Connect the conductivity sensor to the meter.
2. In the measured value display, select the conductivity parameter with **<M>**.
3. Start the calibration with **<CAL>**.  
The cell constant that was calibrated last is displayed.

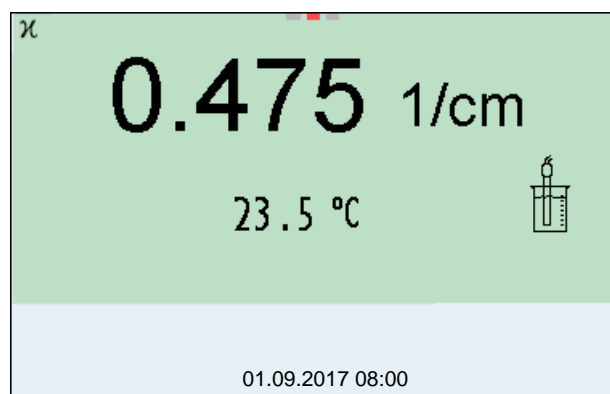

4. Immerse the conductivity sensor in the check- and calibration standard (e.g. 4310: 0.01 mol/l KCl (1413 µS/cm @ 25 °C)) .
5. Start the measurement with **<ENTER>**.  
The measured value is checked for stability (stability control).  
The [AR] status indicator is displayed. The measured parameter flashes.
6. Wait for the end of the measurement with stability control (beep, [HOLD][AR] status indicator) or take over the calibrated value with **<ENTER>**.  
The calibration record is displayed and output to the interface.
7. Switch to the measured value display with **<ENTER>**.

### 9.3.5 Setting the cell constant (calibration with freely selectable check- and calibration standard)

You can set within a valid range the cell constant of the IDS conductivity sensor (setting range: see sensor operating manual).

With a freely selectable check- and calibration standard with known conductivity nominal value (within the measuring range of the sensor), you can exactly adjust the cell constant to the check- and calibration standard by the changing conductivity value displayed.

In the default condition, the cell constant is set to the nominal cell constant of the IDS sensor.

For this calibration procedure, the *Type* setting must be set to *man*. Proceed as follows to set the cell constant:

1. Connect the conductivity sensor to the meter.
2. In the measured value display, select the conductivity parameter with **<M>**.
3. Open the menu for measurement settings with **<ENTER>**.
4. Select the setting of the cell constant  
(4310: Menu *Type: man* and *Man. cell const.*  
4320: Menu *Cell constant*)  
The current conductivity value is displayed in the status line.
5. Set the suitable temperature compensation and reference temperature for the check- and calibration standard.

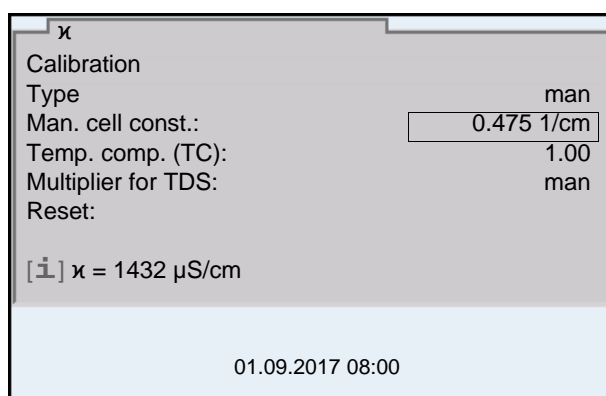

6. Immerse the conductivity sensor in the check- and calibration standard. Wait for a stable measured value.
7. Using **<▲><▼>**, adjust the cell constant until the displayed conductivity value ([i] κ = ...) corresponds to the nominal value.
8. Switch to the measured value display with **<M>**.  
The setting of the cell constant is taken over.  
No calibration record is output.

### 9.3.6 Calibration data



The calibration record is automatically transmitted to the interface after calibrating.

The calibration record of the last calibration is available in the menu *Calibration / Calibration record*. To open it in the measured value display, press the **<CAL\_>** key.

The calibration records of the last 10 calibrations are available in the menu *Calibration / Calibration data storage / Display*. To open the *Calibration* menu in the measured value display, press the **<ENTER>** key.

Menu item	Setting/function	Explanation
<i>Calibration / Calibration data storage / Display</i>	-	Displays the calibration records.  Further options: <ul style="list-style-type: none"> <li>● Scroll through the calibration records with <b>&lt;&lt;&gt;&gt;&lt;&gt;&gt;</b>.</li> <li>● Using <b>&lt;PRT&gt;</b>, output the displayed calibration record to the interface USB-B (<i>USB Device</i>, e.g. PC) or USB-A (<i>USB Host</i>, e.g. USB printer).</li> <li>● Using <b>&lt;PRT_&gt;</b>, output all calibration records to the interface USB-B (<i>USB Device</i>, e.g. PC) or USB-A (<i>USB Host</i>, e.g. USB printer).</li> <li>● Quit the display with <b>&lt;ESC&gt;</b>.</li> <li>● Switch directly to the measured value display with <b>&lt;M&gt;</b>.</li> </ul>
<i>Calibration / Calibration data storage / Output to USB flash drive or printer</i>	-	Outputs the stored calibration data to the USB-A interface ( <i>USB Host</i> , e.g. USB memory device/USB printer) (see section 12 TRANSMITTING DATA, page 120).
<i>Calibration / Calibration data storage / Output to RS232/USB</i>	-	Outputs the stored calibration data to the USB-B interface ( <i>USB Device</i> , e.g. PC) (see section 12 TRANSMITTING DATA, page 120).

#### Calibration evaluation

After calibration, the meter automatically evaluates the current status of the calibration. The evaluation appears on the display and in the calibration record.

Display	Calibration record	Cell constant [cm <sup>-1</sup> ]
	+++	Within the range 0.450 ... 0.500 cm <sup>-1</sup>

Display	Calibration record	Cell constant [ $\text{cm}^{-1}$ ]
<i>Error</i> Error elimination (see section 14 WHAT TO DO IF..., page 128)	<i>Error</i>	Outside the range 0.450 ... 0.500 $\text{cm}^{-1}$

**Calibration record  
(example)**

```
CALIBRATION Cond
01.09.2017 07:43:33

4310
Ser. no. 09250033

Cell constant          0.476 1/cm
25.0 °C
Sensor                +++
```



## 10 Settings

### 10.1 pH measurement settings

#### 10.1.1 Settings for pH measurements

The settings are made in the menu for calibration and measurement settings of the pH/ORP measurement. To open the settings, display the required measured parameter in the measured value display and press the **<ENTER>** key. After completing the settings, switch to the measured value display with **<M>**. Default settings are printed in **bold**.

Menu item	Possible setting	Explanation
<i>Calibration / Calibration record</i>	-	Displays the calibration record of the last calibration.
<i>Calibration / Calibration data storage / Display</i>	-	Displays the last calibration records (max. 10)
<i>Calibration / Calibration data storage / Output to RS232/USB</i>	-	Outputs the stored calibration data to the USB-B interface (USB Device, e.g. PC)
<i>Calibration / Calibration data storage / Output to USB flash drive or printer</i>	-	Outputs the stored calibration data to the USB-A interface (USB Host, e.g. USB memory device/USB printer).
<i>Calibration / Buffer</i>	<b>YSI</b> <i>ConCal</i> <i>NIST/DIN</i> ...	Buffer sets to be used for pH calibration. More buffers and details: see section 10.1.2 BUFFER SETS FOR CALIBRATION, page 99 and section 5.2 PH CALIBRATION, page 27.
<i>Calibration / Single-point calibration</i>	<i>yes</i> <b>no</b>	Quick calibration with 1 buffer
<i>Calibration / Calibration interval</i>	<i>1 ... 7 ... 999</i> <i>d</i>	<i>Calibration interval</i> for the IDS pH sensor (in days). The meter reminds you to calibrate regularly by the flashing sensor symbol in the measuring screen.
<i>Calibration / Unit for slope</i>	<b>mV/pH</b> <b>%</b>	Unit of the slope. The % display refers to the Nernst slope of -59.2 mV/pH (100 x determined slope/Nernst slope).
<i>QSC / First calibration</i>	-	Starts the initial calibration with QSC buffers. This menu item is only available as long as no initial calibration was carried out with the connected IDS sensor.
<i>QSC / Record of first calibration</i>	-	Displays the calibration record of the QSC initial calibration.
<i>QSC / Control calibration</i>	-	Starts the control calibration with QSC buffers. This menu item is only available if an initial calibration was carried out with the connected IDS sensor.

Menu item	Possible setting	Explanation
<i>Alternative temperature</i>	<i>on</i> <i>off</i>	Takes over the temperature value from an IDS sensor. This menu item is only available if an IDS adapter and an IDS sensor with integrated temperature sensor are connected.
<i>Temperature from channel</i>	<input type="checkbox"/> <input type="checkbox"/> <input checked="" type="checkbox"/> <input type="checkbox"/> <input checked="" type="checkbox"/> <input type="checkbox"/> <input checked="" type="checkbox"/> <input type="checkbox"/> <input type="checkbox"/>	Selection of the channel (sensor) providing the temperature value. This menu item is only available if an IDS adapter and two IDS sensors with integrated temperature sensors are connected.
<i>Man. temperature</i>	-25... <b>+25</b> ... +130 °C	Entry of the manually determined temperature. This menu item is only available if an IDS adapter is connected.
<i>pH resolution</i>	<b>0.001</b> 0.01 0.1	Resolution of the pH display
<i>mV resolution</i>	<b>0.1</b> 1	Resolution of the mV display
<i>Limit monitoring</i>		With the <i>Limit monitoring</i> function you define the measured values whose exceeding is signaled. An acoustic signal sounds, and at the same time a message is output to the USB interface. You can switch on or off the acoustic signal in the <i>System</i> menu (see section 10.6.1 SYSTEM, page 109).
<i>Limit monitoring/ pH monitoring</i>	<i>on</i> <i>off</i>	Switch on or off the limit signaling device for the pH value.
<i>Limit monitoring/ TP monitoring</i>	<i>on</i> <i>off</i>	Switch on or off the limit signaling device for the temperature value.
<i>Limit monitoring/ pH monitoring/on/ pH upper limit</i>	-2 ... 20	Upper range limit. If it is exceeded, a message is output to the interface USB-B ( <i>USB Device</i> , e.g. PC) or USB-A ( <i>USB Host</i> , e.g. USB printer). This menu item is only visible when the <i>pH monitoring</i> setting is active.
<i>Limit monitoring/ pH monitoring/on/ pH lower limit</i>	-2 ... 20	Lower range limit. If it is exceeded, a message is output to the interface USB-B ( <i>USB Device</i> , e.g. PC) or USB-A ( <i>USB Host</i> , e.g. USB printer). This menu item is only visible when the <i>pH monitoring</i> setting is active.
<i>Limit monitoring/ TP monitoring/on/ TP upper limit</i>	-5 ... +105 °C	Upper range limit. If it is exceeded, a message is output to the interface USB-B ( <i>USB Device</i> , e.g. PC) or USB-A ( <i>USB Host</i> , e.g. USB printer). This menu item is only visible when the <i>TP monitoring</i> setting is active.

Menu item	Possible setting	Explanation
<i>Limit monitoring/ TP monitoring/on/ TP lower limit</i>	-5 ... 105 °C	Lower range limit. If it is exceeded, a message is output to the interface USB-B ( <i>USB Device</i> , e.g. PC) or USB-A ( <i>USB Host</i> , e.g. USB printer). This menu item is only visible when the <i>TP monitoring</i> setting is active.
<i>Reset</i>	-	Resets all sensor settings to the delivery condition (see section 10.7.1 RESETTING THE MEASUREMENT SETTINGS, page 111).

### 10.1.2 Buffer sets for calibration

You can use the buffer sets quoted in the table for an automatic calibration. The pH values are valid for the specified temperature values. The temperature dependence of the pH values is taken into consideration during calibration.

No.	Buffer set *	pH values	at
1	YSI *	4.000 7.000 10.000	25 °C
2	<i>ConCal</i>	Any	Any
3	<i>NIST/DIN</i> DIN buffers according to DIN 19266 and NIST Traceable Buffers	1.679 4.006 6.865 9.180 12.454	25 °C
4	<i>TEC</i> Technical buffers	2.000 4.010 7.000 10.011	25 °C
5	<i>Merck 1*</i>	4.000 7.000 9.000	20°C
6	<i>Merck 2 *</i>	1.000 6.000 8.000 13.000	20°C
7	<i>Merck 3 *</i>	4.660 6.880 9.220	20°C
8	<i>Merck 4 *</i>	2.000 4.000 7.000 10.000	20°C

No.	Buffer set *	pH values	at
9	<i>Merck 5 *</i>	4.010 7.000 10.000	25 °C
10	<i>DIN 19267</i>	1.090 4.650 6.790 9.230	25 °C
11	<i>Mettler Toledo USA *</i>	1.679 4.003 7.002 10.013	25 °C
12	<i>Mettler Toledo EU *</i>	1.995 4.005 7.002 9.208	25 °C
13	<i>Fisher *</i>	2.007 4.002 7.004 10.002	25 °C
14	<i>Fluka BS *</i>	4.006 6.984 8.957	25 °C
15	<i>Radiometer *</i>	1.678 4.005 7.000 9.180	25 °C
16	<i>Baker *</i>	4.006 6.991 10.008	25 °C
17	<i>Metrohm *</i>	3.996 7.003 8.999	25 °C
18	<i>Beckman *</i>	4.005 7.005 10.013	25 °C
19	<i>Hamilton Duracal *</i>	4.005 7.002 10.013	25 °C
20	<i>Precisa *</i>	3.996 7.003 8.999	25 °C
21	<i>Reagecon TEC *</i>	2.000 4.010 7.000 10.000	25 °C

No.	Buffer set *	pH values	at
22	<i>Reagecon 20</i> *	2.000 4.000 7.000 10.000 13.000	20°C
23	<i>Reagecon 25</i> *	2.000 4.000 7.000 10.000 13.000	25 °C
24	<i>Chemsolute</i> *	2.000 4.000 7.000 10.000	20°C
25	<i>USABlueBook</i> *	4.000 7.000 10.000	25 °C

Brand names or trade names are trademarks of their respective owners protected by law.



The buffers are selected in the menu, pH / **<ENTER>** / *Calibration / Buffer* (see section 10.1.1 SETTINGS FOR PH MEASUREMENTS, page 97).

### 10.1.3 Calibration interval

The calibration evaluation is displayed as a sensor symbol.

After the QSC function has been enabled the sensor symbol is replaced by the QSC scale (see section 5.2.9 QSC FUNCTION (SENSOR QUALITY CONTROL), page 39).

After the specified calibration interval has expired the sensor symbol or the QSC scale flashes. It is still possible to measure.



To ensure the high measuring accuracy of the measuring system, calibrate after the calibration interval has expired.

#### Setting the calibration interval

The calibration interval is set to 7 days in the factory. You can change the interval (1 ... 999 days):

1. Open the menu for measurement settings with **<ENTER>**.
2. In the *Calibration / Calibration interval* menu, set the calibration interval with **<▲><▼>**.

3. Confirm the setting with **<ENTER>**.
4. Quit the menu with **<M>**.

## 10.2 ORP measurement settings

**Settings** The settings are made in the menu for measuring settings of the ORP measurement. To open the settings, display the required measured parameter in the measured value display and press the **<ENTER>** key. After completing the settings, switch to the measured value display with **<M>**. Default settings are printed in **bold**.

Menu item	Possible setting	Explanation
<i>mV resolution</i>	<b>0.1</b> 1	Resolution of the mV display
<i>Reset</i>	-	Resets all sensor settings to the delivery condition (see section 10.7.1 RESETTING THE MEASUREMENT SETTINGS, page 111).

## 10.3 ISE measurement settings

The settings are made in the measuring menu of the ISE measurement. To open the settings, activate the relevant measuring window in the measured value display and press the **<ENTER>** key shortly. After completing the settings, switch to the measured value display with **<M>**.

The following settings are possible for ISE measurements:

Menu item	Possible setting	Explanation
<i>Calibration / Calibration record</i>	-	Displays the calibration record of the last calibration.
<i>Calibration / Calibration data storage / Display</i>	-	Displays the last calibration records (max. 10)
<i>Calibration / Calibration data storage / Output to RS232/ USB</i>	-	Outputs the calibration records to the interface.
<i>Man. temperature</i>	-25 ... <b>+25</b> ... +130 °C	Entry of the manually determined temperature. For measurements without temperature sensor only.

Menu item	Possible setting	Explanation
<i>Alternative temperature</i>	<i>on</i> <i>off</i>	Takes over the temperature value from an IDS sensor. This menu item is only available if an IDS adapter and an IDS sensor with integrated temperature sensor are connected.
<i>Temperature from channel</i>	<input type="checkbox"/> <input type="checkbox"/> <input checked="" type="checkbox"/> <input type="checkbox"/> <input checked="" type="checkbox"/> <input type="checkbox"/> <input checked="" type="checkbox"/> <input type="checkbox"/> <input type="checkbox"/>	Selection of the channel (sensor) providing the temperature value. This menu item is only available if an IDS adapter and two IDS sensors with integrated temperature sensors are connected.
<i>ISE setup/ AutoRead criterion</i>	<i>low</i> <i>medium</i> <i>high</i>	Selection of the AutoRead criteria (see section 7.1.1 MEASURING THE ION CONCENTRATION, page 46).
<i>ISE setup/ Ion type</i>	Ag, Br, Ca, Cd, Cl, CN, Cu, F, I, K, Na, NO <sub>3</sub> , Pb, S, NH <sub>3</sub> , NH <sub>4</sub> , CO <sub>2</sub> , ION	Selection of the ion type to be measured.  An ion that is not included in the list can be measured with the setting, ION.
<i>ISE setup/ Unit</i>	<b>mg/l</b> μmol/l mg/kg ppm %	Selection, with which unit the measurement result and calibration standards should be displayed.
<i>ISE setup/ Valency</i>	-8 ... +8	Set the valence ( <i>Valency</i> ) and molar weight ( <i>Molar mass</i> ) for the ion
<i>ISE setup/ Molar mass</i>	1 ... 300 g/mol	(only for <i>ISE setup/ Ion type</i> = ION)
<i>ISE setup/ Density</i>	0.001 ... 9.999 g/ml or kg/l	Adjustable density of the test sample (only with <i>Unit</i> : mg/kg, ppm, %)
<i>Method</i>	<i>Standard addition</i> <i>Standard subtraction</i> <i>Sample addition</i> <i>Sample subtraction</i> <i>Blank value addition</i>	Selection of the available measuring methods.
<i>Start method</i>		Start measurement with the selected method.

## 10.4 D.O. measurement settings

### 10.4.1 Settings for D.O. measurement

The settings are available in the menu for measurement and calibration settings. To open the settings, display the required measured parameter in the measured value display and press the **<ENTER>** key. After completing the settings, switch to the measured value display with **<M>**.

Menu item	Possible setting	Explanation
<i>Calibration / Calibration record</i>	-	Displays the calibration record of the last calibration.
<i>Calibration / Calibration data storage / Display</i>	-	Displays the last calibration records (max. 10)
<i>Calibration / Calibration data storage / Output to USB flash drive or printer</i>	-	Outputs the stored calibration data to the USB-A interface ( <i>USB Host</i> , e.g. USB memory device/USB printer).
<i>Calibration / Calibration data storage / Output to RS232/USB</i>	-	Outputs the stored calibration data to the USB-B interface ( <i>USB Device</i> , e.g. PC)
<i>Calibration / Zero Calibration</i> (only for 4100 Pro-BOD, 5010 with 4011 Adapter)		Starts the 0-point calibration (see section 8.3.6 ZERO CALIBRATION, page 76)
<i>Calibration / Calibration interval</i>	1 ... <b>180</b> ... 999 d	<i>Calibration interval</i> for the D.O. sensor (in days). The meter reminds you to calibrate regularly by the flashing sensor symbol in the measuring screen.
<i>Calibration / Comparison meas.</i>	<i>on</i> <b>off</b>	Enables to adjust the measured value with the aid of a comparison measurement, e.g. Winkler titration. For details, see section 8.3 CALIBRATION, page 73.
<i>FDO Check / Start FDO Check</i> (only for FDO 4410)	-	Starts the check with the FDO Check
<i>FDO Check / Check interval</i> (only for FDO 4410)	1 ... <b>60</b> ... 999 d	Interval for the <i>FDO Check</i> (in days). The meter reminds you to check the sensor regularly by <i>FDO Check</i> status indicator in the measuring screen.



Menu item	Possible setting	Explanation
<i>Salinity/Sal automatic</i> (only for parameter mg/l)	<i>on</i> <i>off</i>	Automatic salt content correction for concentration measurements. The measured salinity value is taken over by a connected conductivity sensor. This menu item is only available if an IDS conductivity sensor is connected.
<i>Salinity/Salinity from channel</i> (only for parameter mg/l)	<input type="checkbox"/> <input type="checkbox"/> <input checked="" type="checkbox"/> <input type="checkbox"/> <input checked="" type="checkbox"/> <input type="checkbox"/> <input checked="" type="checkbox"/> <input type="checkbox"/> <input type="checkbox"/>	Selection of the channel from which the salinity value should be taken over. This menu item is only available if two IDS conductivity sensors are additionally connected.
<i>Salinity/Sal correction</i> (only for parameter mg/l)	<i>on</i> <i>off</i>	Manual salt content correction for concentration measurements.
<i>Salinity/Salinity</i> (only for parameter mg/l)	<b>0.0 ... 70.0</b>	Salinity or salinity equivalent for the salt content correction. This menu item is only available if the automatic salt content correction is switched off and the manual salt content correction is switched on.
<i>Calibration / Sensor cap coefficients</i> (only for ProOBOD)	<i>K1</i> ... <i>K5</i> <i>KC</i>	Enter the cap coefficients here after exchanging the sensor cap. For details, see section 10.4.2 ENTER SENSOR CAP COEFFICIENTS (PROBOD), page 106.
<i>Calibration / Membrane Cap</i> (only for 4100 Pro-BOD, 5010 with 4011 Adapter)	<i>black</i> <i>yellow</i>	After exchanging the sensor cap, select the cap type here.
<i>Resolution</i> (only for ProOBOD)	<b>0.1</b> <b>1</b>	Set a high or low resolution. The setting of the resolution is separately stored for each measured parameter.
<i>Response time t90</i> (only for FDO 4410)	<b>30 ... 300 s</b>	Response time of the signal filter (in seconds). A signal filter in the sensor reduces the limits of variation of the measured value. The signal filter is characterized by the response time t90. This is the time after which 90 % of a signal change is displayed.
<i>DO % Saturation local</i> (only for ProOBOD)	<i>on</i> <i>off</i>	<i>DO % Saturation local</i> is a procedure that takes the local air pressure into account for each saturation measurement. For details, see section 10.4.3 DO % SATURATION LOCAL, page 106.

Menu item	Possible setting	Explanation
<i>Reset</i>	-	Resets all sensor settings to the delivery condition (see section 10.7.1 RESETTING THE MEASUREMENT SETTINGS, page 111).

#### 10.4.2 Enter *Sensor cap coefficients* (ProOBOD)



The values of the coefficients are provided with the sensor cap.

1. Change the digit of the highlighted position with **<▲><▼>**.
2. Go to the next position with **<◀><▶>**.
3. Confirm with **<ENTER>** when a coefficient is completely entered.

#### 10.4.3 *DO % Saturation local*

Irrespective of the height or air pressure, the calibration value is set to 100 %. The function *DO % Saturation local* fulfills the EU regulations for the parameter oxygen saturation [%].

When the *DO % Saturation local* is enabled the display shows an [L] for the parameter oxygen saturation.

D.O. mg/L readings are unaffected by the selection of the *DO % Saturation local* function.

### 10.5 Cond measurement settings

#### 10.5.1 Settings for IDS conductivity sensors

The settings are made in the menu for the measured parameter, conductivity. To open the settings, display the required measured parameter in the measured value display and press the **<ENTER>** key. After completing the settings, switch to the measured value display with **<M>**.

The possible settings are individually displayed for each sensor. Below the setting menu is displayed for two IDS sensors (4310, 4320).

Default settings are printed in **bold**.

General setting  
menu for  
conductivity

Menu item	Possible setting	Explanation
<i>Calibration / Calibration record</i>	-	Displays the calibration record of the last calibration.

Menu item	Possible setting	Explanation
<i>Calibration / Calibration data storage / Display</i>	-	Displays the last calibration records (max. 10)
<i>Calibration / Calibration data storage / Output to USB flash drive or printer</i>	-	Outputs the stored calibration data to the USB-A interface ( <i>USB Host</i> , e.g. USB memory device/USB printer).
<i>Calibration / Calibration data storage / Output to RS232/USB</i>	-	Outputs the stored calibration data to the USB-B interface ( <i>USB Device</i> , e.g. PC)
<i>Calibration / Calibration interval</i>	1 ... <b>150</b> ... 999 d	<i>Calibration interval</i> for the IDS conductivity sensor (in days). The meter reminds you to calibrate regularly by the flashing sensor symbol in the measuring screen.
<i>Reset</i>	-	Resets all sensor settings to the delivery condition (see section 10.7.1 RESETTING THE MEASUREMENT SETTINGS, page 111).

Setting menu  
4310

Menu item	Possible setting	Explanation
<i>Type</i>	<i>Cal</i>  <i>man</i>	Used measuring cell  Measuring cells whose cell constants are determined by calibrating in the KCl control standard (KCl 1413 $\mu\text{S}/\text{cm}$ @25 °C). Calibration range: 0.450 to 0.500 $\text{cm}^{-1}$ The currently valid cell constant is displayed in the status line.  Freely adjustable cell constant in the range 0.450 ... 0.500 $\text{cm}^{-1}$ .
<i>Man. cell const.</i>	0.450 ... <b>0.475</b> ... 0.500 $\text{cm}^{-1}$	Display and setting options for the manually adjustable cell constant. This menu item is only available when <i>Type man</i> is set.

Menu item	Possible setting	Explanation
<i>Temp. comp. (TC) / Method</i>	<b>nLF</b> <i>Lin</i> <i>off</i>	Procedure for temperature compensation (see section 9.2 TEMPERATURE COMPENSATION, page 91). This setting is only available for the measured parameters, conductivity ( $\kappa$ ) and resistivity ( $\rho$ ).
<i>Temp. comp. (TC) / Linear coeff.</i>	<i>0.000 ...</i> <b>2.000 ...</b> <i>3.000 %/K</i>	Coefficient of the linear temperature compensation. This menu item is only available when the linear temperature compensation is set.
<i>Temp. comp. (TC) / Reference temp.</i>	<i>20 °C</i> <b>25 °C</b>	Reference temperature This setting is only available for the measured parameters, conductivity ( $\kappa$ ) and resistivity ( $\rho$ ).
<i>Multiplier for TDS</i>	<i>0.40 ...</i> <b>1.00</b>	Multiplier for TDS value

**Setting menu  
4320**

Menu item	Possible setting	Explanation
<i>Cell constant</i>	<i>0.090 ... ..</i> <b>0.100 ...</b> <i>0.110 cm<sup>-1</sup></i>	Display and setting options for the cell constant
<i>Temp. comp. (TC) / Method</i>	<b>nLF</b> <i>Lin</i> <i>off</i>	Procedure for temperature compensation (see section 9.2 TEMPERATURE COMPENSATION, page 91). This setting is only available for the measured parameters, conductivity ( $\kappa$ ) and resistivity ( $\rho$ ).
<i>Temp. comp. (TC) / Linear coeff.</i>	<i>0.000 ...</i> <b>2.000 ...</b> <i>3.000 %/K</i>	Coefficient of the linear temperature compensation. This menu item is only available when the linear temperature compensation is set.
<i>Temp. comp. (TC) / Reference temp.</i>	<i>20 °C</i> <b>25 °C</b>	Reference temperature This setting is only available for the measured parameters, conductivity ( $\kappa$ ) and resistivity ( $\rho$ ).
<i>Multiplier for TDS</i>	<i>0.40 ...</i> <b>1.00</b>	Multiplier for TDS value

## 10.6 Sensor-independent settings

### 10.6.1 System

To open the *Storage & config* menu, press the **<ENTER\_>** key in the measured value display. After completing the settings, switch to the measured value display with **<M>**.

Default settings are printed in **bold**.

Menu item	Setting	Explanation
<i>System / General / Language</i>	<b>English</b> (more)	Selects the menu language
<i>System / General / Audio signal</i>	<b>on</b> off	Switching on/off the beep
<i>System / General / Brightness</i>	0 ... <b>15</b> ... 22	Changes the display brightness
<i>System / General / Temperature unit</i>	<b>°C</b> °F	Temperature unit, degrees Celsius or degrees Fahrenheit. All temperature values are displayed with the selected unit.
<i>System / General / Barometric pressure unit</i>	mbar <b>mmHg</b> inHg	Air pressure unit
<i>System / General / Stability control</i>	<b>on</b> off	Switches on or off the automatic stability control during measurement (see section 10.6.3 AUTOMATIC STABILITY CONTROL, page 110 )
<i>System / Interface / Baud rate</i>	1200, 2400, <b>4800</b> , 9600, 19200	Baud rate of the USB-B interface ( <i>USB Device</i> )
<i>System / Interface / Output format</i>	<b>ASCII</b> CSV	Output format for data transmission For details, see section 12 TRANSMITTING DATA, page 120
<i>System / Interface / Decimal separator</i>	<b>Dot (xx.x)</b> Comma (xx,x)	Decimal separator
<i>System / Interface / Output header</i>		Output of a header for <i>Output format</i> . CSV
<i>System / Clock function</i>	<b>Date format</b> Datum Time	Settings of time and date. For details, see section 4.4.5 EXAMPLE 2 ON NAVIGATION: SETTING THE DATE AND TIME, page 23
<i>System / Service information</i>		Hardware version and software version of the meter are displayed.
<i>System / Reset</i>	-	Resets the system settings to the default values. For details, see section 10.7.2 RESET- TING THE SYSTEM SETTINGS, page 113

### 10.6.2 *Data storage*

This menu contains all functions to display, edit and erase stored measured values.



Detailed information on the storage functions of the MultiLab 4010-3W are given in section 11 DATA STORAGE, page 114.

### 10.6.3 *Automatic Stability control*

The automatic *Stability control* (AutoRead) function continuously checks the stability of the measurement signal. The stability has a considerable impact on the reproducibility of measured values.

You can activate or switch off the automatic *Stability control* function (see section 10.6 SENSOR-INDEPENDENT SETTINGS, page 109).

The measured parameter flashes on the display

- as soon as the measured value is outside the stability range
- when you switch over between the measured parameters with **<M>**.
- when the automatic *Stability control* is switched off.

## 10.7 Reset

You can reset (initialize) all sensor settings and sensor-independent settings separately from each other.

### 10.7.1 Resetting the measurement settings



The calibration data are reset to the default settings together with the measuring parameters. Recalibrate after performing a reset.

**pH** The following settings for pH measurements are reset to the default settings with the *Reset* function:

Setting	Default settings
<i>Buffer</i>	YSI
<i>Calibration interval</i>	7 d
<i>Unit for slope</i>	mV/pH
<i>Measured parameter</i>	pH
<i>pH resolution</i>	0.001
<i>mV resolution</i>	0.1
<i>Asymmetry</i>	0 mV
<i>Slope</i>	-59.2 mV
<i>Man. temperature</i>	25 °C
<i>Single-point calibration</i>	off

The sensor settings are reset under the *Reset* menu item in the menu for calibration and measurement settings. To open the settings, display the required measured parameter in the measured value display and press the **<ENTER>** key.

**ORP** The following settings for ORP measurements are reset to the default settings with the *Reset* function:

Setting	Default settings
<i>mV resolution</i>	0.1

The sensor settings are reset under the *Reset* menu item in the menu for calibration and measurement settings. To open the settings, display the required measured parameter in the measured value display and press the **<ENTER>** key.

**ISE** The following settings for ISE measurements are reset to the default settings with the *Reset* function:

Setting	Default settings
<i>AutoRead criterion</i>	<i>high</i>
<i>Ion type</i>	Ag
<i>Unit</i>	mg/l
<i>Man. temperature</i>	25 °C
<i>Alternative temperature</i>	<i>off</i>
<i>Method</i>	<i>Standard addition</i>

The sensor settings are reset under the *Reset* menu item in the menu for calibration and measurement settings. To open the settings, display the required measured parameter in the measured value display and press the **<ENTER>** key.

**Dissolved oxygen** The following settings for D.O. measurements are reset to the default settings with the *Reset* function:

Setting	Default settings
<i>Calibration interval</i>	180 d
<i>Measured parameter</i>	D.O. concentration (mg/l)
<i>Salinity (value)</i>	0,0
<i>Salinity (function)</i>	Off
<i>Number of cal. points</i>	1
<i>Resolution</i>	0.1
<i>DO % Saturation local</i>	off

The sensor settings are reset under the *Reset* menu item in the menu for calibration and measurement settings. To open the settings, display the required measured parameter in the measured value display and press the **<ENTER>** key.



**Conductivity** The following settings for conductivity measurements are reset to the default settings with the *Reset* function:

Setting	Default settings
<i>Calibration interval</i>	150 d
<i>Measured parameter</i>	$\kappa$
<i>Cell constant (c)</i>	Depending on the connected measuring cell: 0.475 cm <sup>-1</sup> (calibrated) 0.475 cm <sup>-1</sup> (set) 0.100 cm <sup>-1</sup>
<i>Temperature compensation</i>	nLF
<i>Reference temperature</i>	25 °C
<i>Temperature coefficient (TC) of the linear temperature compensation</i>	2.000 %/K
<i>TDS multiplier</i>	1.00

The sensor settings are reset under the *Reset* menu item in the menu for calibration and measurement settings. To open the settings, display the required measured parameter in the measured value display and press the **<ENTER>** key.

### 10.7.2 Resetting the system settings

The following system settings can be reset to the default status:

Setting	Default settings
<i>Language</i>	English
<i>Audio signal</i>	on
<i>Baud rate</i>	4800 Baud
<i>Output format</i>	ASCII
<i>Decimal separator</i>	Dot (xx.x)
<i>Brightness</i>	10
<i>Temperature unit</i>	°C
<i>Stability control</i>	on

The resetting of the system settings is done in the menu *Storage & config / System / Reset*. To open the menu *Storage & config* in the measured value display, press the **<ENTER\_>** key.

## 11 Data storage

You can transmit measured values (datasets) to the data storage:

- Manual data storage (see section 11.1 MANUAL STORAGE, page 114)
- Automatic data storage at intervals (see section 11.2 AUTOMATIC DATA STORAGE AT INTERVALS, page 114)

### 11.1 Manual storage

You can store a measurement dataset to the data storage as follows. At the same time, the dataset is output to the interface USB-B (*USB Device*, e.g. PC) or USB-A (*USB Host*, e.g. USB printer):

1. Press the **<STO>** key shortly.  
The menu for manual data storage appears.

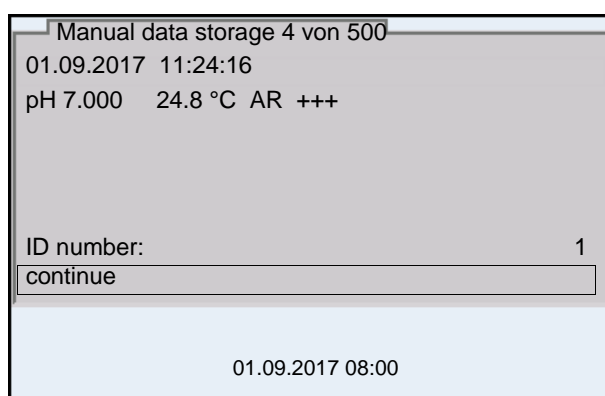

2. If necessary, change and confirm the ID number (1 ... 10000) with **<▲><▼>** and **<ENTER>**.  
The dataset is stored. The meter switches to the measured value display.

#### When the storage is full

When all storage locations are occupied, it is not possible to continue storing. Then you can e.g. transmit the stored data to a PC or a USB flash drive (see section 11.3.1 MANAGING THE MEASUREMENT DATA STORAGE, page 117) and subsequently erase the storage (see section 11.3.2 ERASING THE MEASUREMENT DATA STORAGE, page 118).

### 11.2 Automatic data storage at intervals

The storing interval (*Interval*) determines the time interval between automatic data storing processes. With any storing process, the dataset is simultaneously output to the interface USB-B (*USB Device*, e.g. PC) or USB-A (*USB Host*, e.g. USB printer).

#### Configuring the automatic storing function

1. Press the **<STO\_>** key.  
The menu for automatic data storing appears.

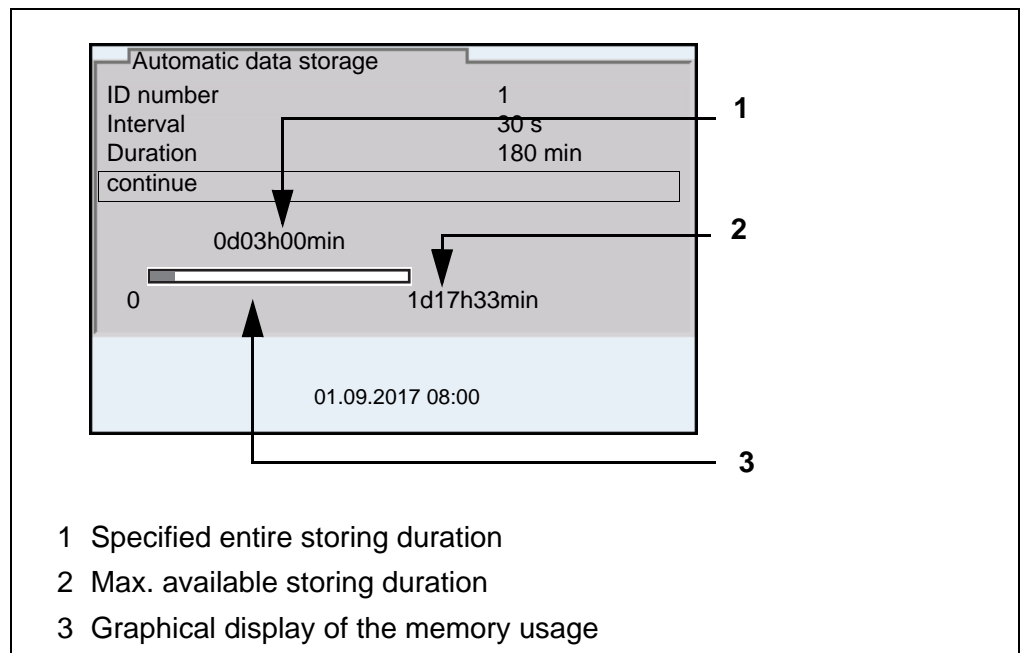

**Settings** You can configure the automatic data storing function with the following settings:

Menu item	Possible setting	Explanation
<i>ID number</i>	1 ... 10000	ID number for the dataset series.
<i>Interval</i>	1 s, 5 s, 10 s, 30 s, 1 min, 5 min, 10 min, 15 min, 30 min, 60 min	Storing interval. The lower limit of the storing interval can be restricted by the number of free storage locations. The upper limit is restricted by the storing duration.
<i>Duration</i>	1 min ... x min	Storing duration. Specifies after which time the automatic data storing should be terminated. The lower limit of the storage duration is restricted by the storage interval. The upper limit is restricted by the number of free storage locations.

### Starting the automatic storing function

To start the automatic storing function, select *continue* with **<▲>****<▼>** and confirm with **<ENTER>**. The meter switches to the measured value display.

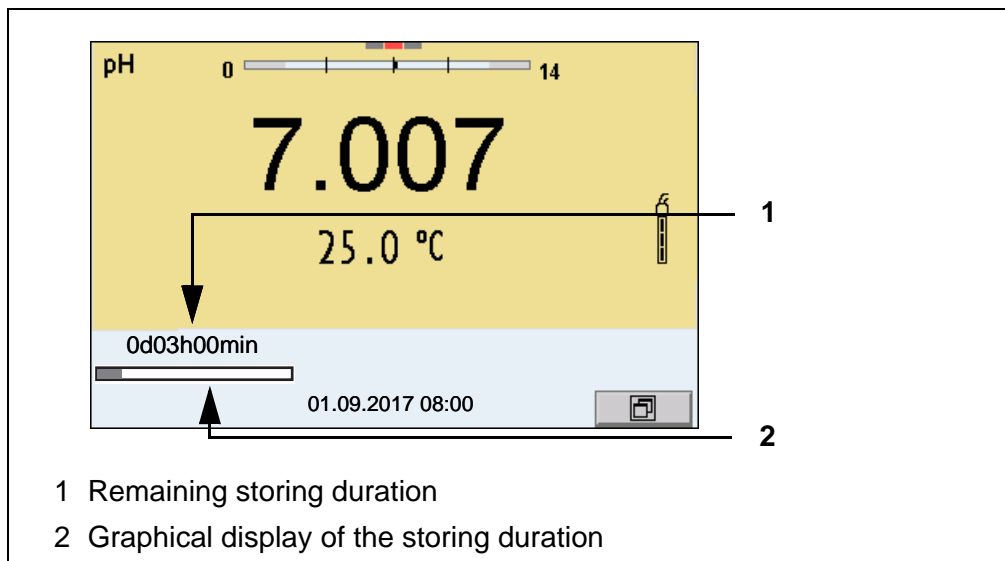

The active automatic data storing function can be recognized by the progress bar in the status line. The progress bar indicates the remaining storage duration.



If the automatic data storage function is activated, only the following keys are active: **<M>****<▲>****<▼>****<STO\_>** and **<On/Off>**. The other keys and the automatic switch-off function are deactivated.

### Terminating the automatic storage function prematurely

Proceed as follows to switch off the automatic data storing function before the adjusted storing duration has expired:

1. Press the **<STO\_>** key.  
The following window appears.

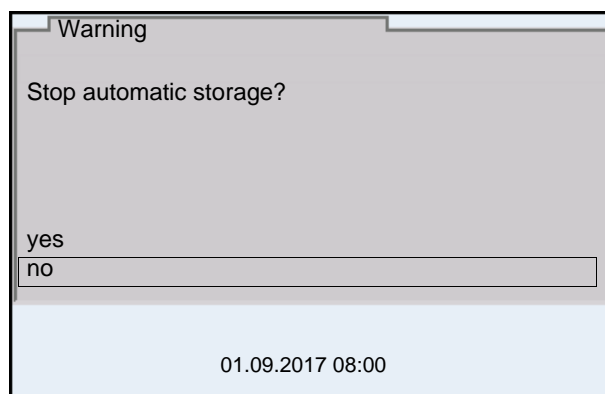

2. Using **<▲>****<▼>**, select **yes** and confirm with **<ENTER>**.  
The meter switches to the measured value display.  
The automatic data storing function is terminated.

## 11.3 Measurement data storage

### 11.3.1 Managing the measurement data storage

For each measurement data storage (automatic and manual) the following functions are available:

- *Display*
- *Output to RS232/USB*
- *Erase*

The storage is edited in the menu *Storage & config/ Data storage*. To open the *Storage & config* menu, press the **<ENTER\_>** key in the measured value display.

Open the manual or automatic storage directly with the **<RCL>** or **<RCL\_>** key.



The settings are explained here using the manual data storage as an example. The same settings and functions are available for the automatic data storage and OUR/SOUR.

#### Settings

Menu item	Setting/ function	Explanation
<i>Data storage / Manual data storage / Display</i>	-	Displays all measurement datasets page by page.  Further options: <ul style="list-style-type: none"> <li>● Scroll through the datasets with <b>&lt;◀&gt;&lt;▶&gt;</b>.</li> <li>● Output the displayed dataset to the interface with <b>&lt;PRT&gt;</b>.</li> <li>● Quit the display with <b>&lt;ESC&gt;</b>.</li> </ul>
<i>Data storage / Manual data storage / Output to USB flash drive or printer</i>	-	Outputs all stored measured values to the USB-A interface ( <i>USB Host</i> , e.g. USB memory device/ USB printer)
<i>Data storage / Manual data storage / Output to RS232/USB</i>	-	Outputs all stored measurement data to the USB-B interface ( <i>USB Device</i> , e.g. PC)
<i>Data storage / Manual data storage / Erase</i>	-	Erases the entire manual measurement data storage. Note: All calibration data remain stored when this action is performed.

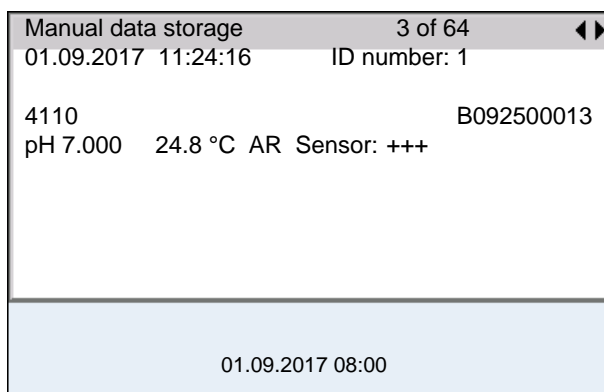
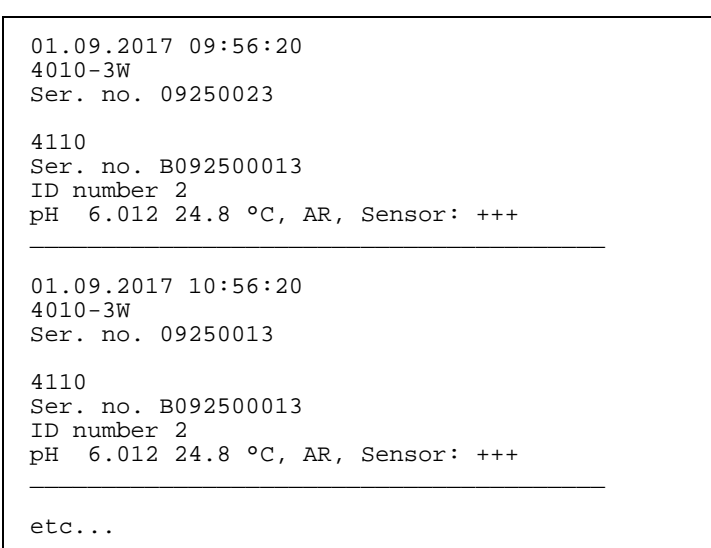
**Display presentation  
of a dataset****Sample printout****Quitting the display**

To quit the display of stored measurement datasets, you have the following options:

- Switch directly to the measured value display with **<M>**.
- Quit the display and move to the next higher menu level with **<ESC>**.

**11.3.2 Erasing the measurement data storage**

How to erase the measured value storage is described in section 11.3.1 MANAGING THE MEASUREMENT DATA STORAGE, page 117.

**11.3.3 Measurement dataset**

A complete dataset consists of:

- Date/time
- Meter name, serial number
- Sensor name, serial number
- ID number

- Measured value of the connected sensor
- Measured temperature value of the connected sensor
- AutoRead info: *AR* appears with the measured value if the AutoRead criterion was met while storing (stable measured value). Otherwise, the *AR* display is missing.
- Calibration evaluation:
  - 4 levels (+++, ++, +, -, or no evaluation) or
  - QSC (percentage)

#### 11.3.4 Storage locations

The MultiLab 4010-3W meter has two measurement data memories. The measured values recorded either manually or automatic are stored separately in individual measurement data memories.

<b>Data storage</b>	<b>Maximum number of datasets</b>
<i>Manual data storage</i>	500
<i>Automatic data storage</i>	10000
<i>OUR/SOUR data storage</i>	20

## 12 Transmitting data

The meter has the following interfaces:

- USB-B interface (*USB Device*)  
e.g. to connect a PC
- USB-A interface (*USB Host*),  
e.g. to connect a USB flash drive/USB printer

Via the USB-B interface (*USB Device*) you can transmit data to a PC or printer and update the meter software.

Via the USB-A interface (*USB Host*) it is possible to transfer data to an external USB memory device/USB printer.

### 12.1 Saving data to a USB memory device

Via the USB-A interface (*USB Host*) you can transmit data to a USB memory device or USB printer.



The USB memory device must be formatted with one of the following file systems: FAT, FAT32.

How to transmit data to a USB printer is described in an extra section (see section 12.2 TRANSMITTING DATA TO A USB PRINTER, page 121).

#### Connecting the USB memory device

1. Connect a USB memory device to the USB-A interface (*USB Host*). When the USB memory device is identified the USB display indicator is displayed.

#### Transmitting data (options)

Data	Control	Operation / description
Stored measured values	Manual	All datasets with the function, <i>Output to USB flash drive or printer</i> (menu <i>Data storage / Manual data storage</i> or <i>Automatic data storage</i> ).  For details, see section 11.3.1 MANAGING THE MEASUREMENT DATA STORAGE, page 117
Calibration data storage	Manual	All stored calibration records of a sensor with the function, <i>Output to USB flash drive or printer</i> (menu <i>Calibration / Calibration data storage</i> ). For details, see menu for calibration and measurement settings of the sensor.



2. After successful data transmission:  
The data transmitted are stored in the "DATAMEM" directory of the USB memory device.

## 12.2 Transmitting data to a USB printer

Via the USB-A interface (*USB Host*) you can transmit data to a USB printer or USB memory device. How to transmit data to a USB memory device is described in an extra section (see section 12.1 SAVING DATA TO A USB MEMORY DEVICE, page 120).

### Connecting a USB printer

Suitable USB printers

Model	Type	Paper width
Citizen CT-S281	Thermal transfer printer	58 mm
Seiko Instruments Inc. DPU-S445*	Thermal transfer printer	58 mm
Star SP700 with USB interface**	Matrix printer	76 mm

\* Recommended printer settings for DPU-S445:

- Character Set : IBM Compatible

\*\* Recommended printer settings for Star SP700:

- CodePage 437

- DIP switch 1...7: =ON, DIP switch 8: OFF

Details: see operating manual of your printer.

1. Connect the USB printer to the *USB Host* interface.
2. Connect the power pack to the MultiLab 4010-3W (see section 3.3.1 CONNECTING THE POWER PACK, page 13).  
As soon as the USB printer is identified by the meter, the printer status indicator [  ] is displayed.

### Transmitting data (options)

The following table shows which data are transmitted to the interface in which way:

Data	Control	Operation / description
Current measured values of all connected sensors	Manual	<ul style="list-style-type: none"> <li>● Press <b>&lt;PRT&gt;</b></li> <li>● Simultaneously with every manual storing process (see section 11.1 MANUAL STORAGE, page 114).</li> </ul>
	Automatic, at intervals	<ul style="list-style-type: none"> <li>● With <b>&lt;PRT_&gt;</b>. Then you can set the transmission interval</li> <li>● Simultaneously with every automatic storing process (see section 11.2 AUTOMATIC DATA STORAGE AT INTERVALS, page 114).</li> </ul>
Stored measured values	Manual	<ul style="list-style-type: none"> <li>● Displayed dataset with <b>&lt;PRT&gt;</b> after calling up from the storage.</li> <li>● All datasets with the function, <i>Output to USB flash drive or printer</i> (menu <i>Data storage / Manual data storage</i> or <i>Automatic data storage</i>).</li> </ul> <p>For details, see section 11.3.1 MANAGING THE MEASUREMENT DATA STORAGE, page 117.</p>
Calibration records	Manual	<ul style="list-style-type: none"> <li>● Displayed calibration record with <b>&lt;PRT&gt;</b></li> <li>● All stored calibration records of a sensor with the function, <i>Output to USB flash drive or printer</i> (menu <i>Calibration / Calibration data storage</i>).</li> </ul> <p>For details, see menu for calibration and measurement settings of the sensor.</p>
	Automatic	<ul style="list-style-type: none"> <li>● At the end of a calibration procedure</li> </ul>



The following rule applies: With the exception of the menus, shortly pressing the **<PRT>** key generally outputs the display contents to the interface (displayed measured values, measuring datasets, calibration records). If there is a USB-B connection (*USB Device*), e.g. to a PC, the data are output to the USB-B interface only (*USB Device*).

### 12.3 Transmitting data to a PC

Via the USB-B interface (*USB Device*) you can transmit data to a PC.

#### PC system requirements

- Microsoft Windows (for details, see enclosed installation CD, *Driver* directory)
- Installed USB driver for the meter (see CD-ROM or Internet)

- Settings for the USB/RS232 interface on the PC and meter in agreement
- Program to receive the measurement data on the PC (e.g. MultiLab Importer, see CD-ROM or Internet)

**Installation of the USB driver**

1. Insert the supplied installation CD in the CD drive of your PC.  
or  
Download the USB driver from the Internet and unpack the files and folders.
2. Start the driver installation (32 bits or 64 bits) suitable for your operating system.  
Follow the Windows installation instructions as necessary.

**Connecting a PC**

1. Connect the MultiLab 4010-3W to the PC via the USB-B interface (*USB Device*).  
The meter is listed as a virtual COM interface among the connections in the Windows device manager.

**Adjusting the settings for the data transmission**

2. Set the same transmission data at the meter and PC:
  - Baud rate: to be selected in the range 1200 ... 19200
  - Set at the PC only:
    - Handshake: RTS/CTS
    - Parity: none
    - Data bits: 8
    - Stop bits: 1

**Starting the program for the data reception**

3. On the PC, start the program for the data reception, e.g.:
  - MultiLab Importer (see section 12.4 MULTILAB IMPORTER, page 124)
  - Terminal program

Transmitting data  
(options)

Data	Control	Operation / description
Current measured values of all connected sensors	Manual	<ul style="list-style-type: none"> <li>● Press <b>&lt;PRT&gt;</b></li> <li>● Simultaneously with every manual storing process (see section 11.1 MANUAL STORAGE, page 114).</li> </ul>
	Automatic, at intervals	<ul style="list-style-type: none"> <li>● With <b>&lt;PRT_&gt;</b>. Then you can set the transmission interval</li> <li>● Simultaneously with every automatic storing process (see section 11.2 AUTOMATIC DATA STORAGE AT INTERVALS, page 114).</li> </ul>
Stored measured values	Manual	<ul style="list-style-type: none"> <li>● Displayed dataset with <b>&lt;PRT&gt;</b> after calling up from the storage.</li> <li>● All datasets with the function, <i>Output to RS232/USB</i> (menu <i>Data storage / Manual data storage</i> or <i>Automatic data storage</i>).</li> </ul> <p>For details, see section 11.3.1 MANAGING THE MEASUREMENT DATA STORAGE, page 117.</p>
Calibration records	Manual	<ul style="list-style-type: none"> <li>● Displayed calibration record with <b>&lt;PRT&gt;</b></li> <li>● All calibration records with <i>Output to RS232/USB</i> (menu <i>Calibration / Calibration data storage</i>)</li> </ul>
	Automatic	<ul style="list-style-type: none"> <li>● At the end of a calibration procedure</li> </ul>



The following rule applies: With the exception of the menus, shortly pressing the **<PRT>** key generally outputs the display contents to the interface (displayed measured values, measuring datasets, calibration records). If there is a USB-B connection (*USB Device*), e.g. to a PC, the data are output to the USB-B interface only (*USB Device*).

## 12.4 MultiLab Importer

With the aid of the MultiLab Importer software, you can record and evaluate measurement data with a PC.



More detailed information can be found in the MultiLab Importer operating manual.

## 12.5 BOD Analyst Pro

With the aid of the BOD Analyst Pro software you can administrate BOD measurement on the PC and automatically calculate the measured values.



More detailed information can be found in the BOD Analyst Pro operating manual.

## 13 Maintenance, cleaning, disposal

### 13.1 Maintenance

#### 13.1.1 General maintenance activities

The only maintenance activity required is exchanging the battery that buffers the system clock.



See the relevant operating manuals of the IDS sensors for instructions on maintenance.

#### 13.1.2 Exchanging the battery

The MultiLab 4010-3W has a battery (CR2032 type) to buffer the system clock in case of a power failure.



To retain the current setting of the date and time during the battery exchange, supply the meter with power with the power pack while changing the battery.

To avoid that the system clock is reset in the case of a power failure, we recommend changing the battery before the end of its service life (the battery included in the scope of delivery after approx. 5 years).

1. Unscrew the screws (2) of the lid of the battery compartment with a screwdriver.

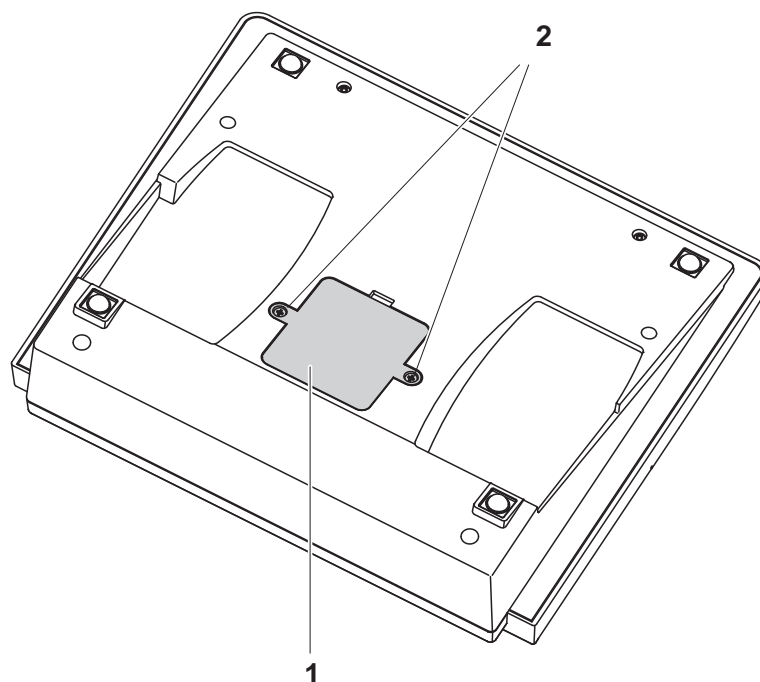

2. Open the battery compartment (1) on the underside of the meter.

3. Remove the battery from the battery compartment.
4. Insert a new battery in the battery compartment.
5. Close the battery compartment (1).
6. Tighten the screws (2) of the lid of the battery compartment with a screwdriver.
7. Set the date and time (see 4.4.5 EXAMPLE 2 ON NAVIGATION: SETTING THE DATE AND TIME, PAGE 23)



Dispose of used batteries according to the local regulations of your country.

End users within the European Union are obligated to return used batteries (even ecologically compatible ones) to a collection point set up for recycling purposes.

Batteries are marked with the crossed-out waste container symbol. Therefore, they may not be disposed with the domestic waste.

### 13.2 Cleaning

Occasionally wipe the outside of the measuring instrument with a damp, lint-free cloth. Disinfect the housing with isopropanol as required.



#### **CAUTION**

**The housing is made of synthetic material (ABS). Thus, avoid contact with acetone or similar detergents that contain solvents. Remove any splashes immediately.**

### 13.3 Packing

This meter is sent out in a protective transport packing.

We recommend: Keep the packing material. The original packing protects the meter against damage during transport.

### 13.4 Disposal

At the end of its operational lifetime, the meter must be returned to the disposal or return system statutory in your country. If you have any questions, please contact your supplier.

## 14 What to do if...

### 14.1 pH



More information and instructions on cleaning and exchange of sensors are given in the documentation of your sensor.

#### Error message *OFL, UFL*

Cause	Remedy
IDS pH sensor:	
– Measured value outside the measuring range	– Use suitable IDS pH sensor
– Air bubble in front of the junction	– Remove air bubble (e.g. sway or stir the solution)
– Air in the junction	– Extract air or moisten junction
– Cable broken	– Exchange IDS pH sensor
– Gel electrolyte dried out	– Exchange IDS pH sensor

#### Error message, *Error*

Cause	Remedy
IDS pH sensor:	
– The values determined for zero point and slope of the IDS pH sensor are outside the allowed limits.	– Recalibrate
– Junction contaminated	– Clean the junction
– IDS pH sensor broken	– Exchange IDS pH sensor
Buffer solutions:	
– The used buffer solutions do not agree with the set buffer set	– Set different buffer set or – Use different buffer solutions
– Buffer solutions too old	– Use only once. Note the shelf life
– Buffer solutions depleted	– Change solutions



<b>No stable measured value</b>	<b>Cause</b>	<b>Remedy</b>
	IDS pH sensor:	
	– Sensor soiled	– Clean the sensor
	Test sample:	
	– pH value not stable	– Measure with air excluded if necessary
	– Temperature not stable	– Adjust temperature if necessary
	IDS pH sensor + test sample:	
	– Conductivity too low	– Use suitable IDS pH sensor
	– Temperature too high	– Use suitable IDS pH sensor
	– Organic liquids	– Use suitable IDS pH sensor
<b>Obviously incorrect measured values</b>	<b>Cause</b>	<b>Remedy</b>
	IDS pH sensor:	
	– IDS pH sensor unsuitable	– Use suitable IDS sensor
	– Temperature difference between buffer and test sample too great	– Adjust temperature of buffer or sample solutions
	– Measurement procedure not suitable	– Follow special procedure

## 14.2 ISE

<b>Error message <i>OFL</i></b>	<b>Cause</b>	<b>Remedy</b>
	– Measuring range exceeded	– Dilute test sample
<b>Obviously incorrect measured values</b>	<b>Cause</b>	<b>Remedy</b>
	– Electrode not connected	– Connect the electrode
	– Cable broken	– Replace the electrode
<b>Error message <i>Error</i> (Failed calibration) or Calibration evaluation <i>poor</i> (-)</b>	<b>Cause</b>	<b>Remedy</b>
	<i>ISE electrode:</i>	
	– Moisture in the plug	– Dry plug
	– Electrode obsolete	– Replace the electrode
	– Electrode unsuitable for the range to be measured	– Use a suitable electrode
	– Electrode not suitable for the selected ion	– Use a suitable electrode or select a suitable ion
	– Socket damp	– Dry socket
	– Electrode not ready for operation	– Heed the instruction on maintenance and storage. – Refill the reference electrolyte and/or exchange the sensor module (if possible).
	– Refilling opening of the electrode not open	– Open the refilling opening of the electrode (if existing)
	– The junction is not immersed in the test sample	– Completely submerge the outer junction in the test sample or standard. – The filling level of the inner solution (if refillable) must be higher than the test sample or standard.
	<i>Calibration procedure:</i>	
– Wrong sequence of standards for 3- to 7-point calibration	– Select correct sequence	
– Calibration standards do not have the correct temperature (max. $\pm 2$ °C temperature difference)	– Adjust the temperature of the calibration standards	

	Cause	Remedy
	<ul style="list-style-type: none"> <li>– Calibration standards not suitable</li> </ul>	<ul style="list-style-type: none"> <li>– Make new calibration standards using the sample conditioning solution (ISA).</li> <li>– Stir the solution</li> </ul>
<b>Warning [TpErr]</b>	<ul style="list-style-type: none"> <li>– Temperature difference between measurement and calibration greater than 2 °C.</li> </ul>	<ul style="list-style-type: none"> <li>– Adjust the temperature of the test sample</li> </ul>
<b>Warning [ISEErr]</b>	<ul style="list-style-type: none"> <li>– Electrode voltage outside calibrated range</li> </ul>	<ul style="list-style-type: none"> <li>– Recalibrate</li> </ul>

### 14.3 Dissolved oxygen



More information and instructions on cleaning and exchange of sensors are given in the documentation of your sensor.

	Cause	Remedy
<b>Error message, OFL</b>	<ul style="list-style-type: none"> <li>– Measured value outside the measuring range</li> </ul>	<ul style="list-style-type: none"> <li>– Select a suitable measuring medium</li> </ul>
<b>Error message, Error</b>	<ul style="list-style-type: none"> <li>– Sensor contaminated</li> <li>– Measured temperature value outside the operating conditions (display of OFL/UFL instead of a temperature value)</li> <li>– Calibration failed</li> <li>– Defective sensor</li> </ul>	<ul style="list-style-type: none"> <li>– Clean the sensor</li> <li>– Keep to the temperature range for the test sample</li> <li>– Recalibrate</li> <li>– Calibration</li> <li>– Exchange the sensor cap</li> <li>– Replace the sensor</li> </ul>

## 14.4 Conductivity



More information and instructions on cleaning and exchange of sensors are given in the documentation of your sensor.

Error message, <i>OFL</i>	Cause	Remedy
	– Measured value outside the measuring range	– Use suitable IDS conductivity sensor

Error message, <i>Error</i>	Cause	Remedy
	– Sensor contaminated	– Clean the sensor and replace it if necessary
– Calibration solution not suitable	– Check the calibration solutions	



More information and instructions on cleaning and exchange of sensors are given in the documentation of your sensor.

## 14.5 General topics

Sensor symbol flashes	Cause	Remedy
	– Calibration interval expired	– Recalibrate the measuring system

Meter does not react to keystroke	Cause	Remedy
	– Operating condition undefined or EMC load unallowed	– Processor reset: Press the <b>&lt;ENTER&gt;</b> and <b>&lt;On/Off&gt;</b> key simultaneously

<b>You want to know which software version is in the meter or IDS sensor</b>	<b>Cause</b> <ul style="list-style-type: none"> <li>– E.g., a question by the service department</li> </ul>	<b>Remedy</b> <ul style="list-style-type: none"> <li>– Switch on the meter.</li> <li>– Open the menu, <b>&lt;ENTER_&gt;</b> / <i>Storage &amp; config / System / Service information</i>. The instrument data are displayed.</li> </ul> <p>or</p> <ul style="list-style-type: none"> <li>– Connect the sensor. Press softkey [<b>i</b>]/[More] The sensor data are displayed (see section 4.1.6 SENSOR INFO, page 17)</li> </ul>
<b>Data transmission to USB memory device does not work</b>	<b>Cause</b> <ul style="list-style-type: none"> <li>– Connected USB memory device was not recognized</li> <li>– The USB-B interface is connected to a PC</li> <li>– The USB memory device has been formatted to a file system which is not supported, e. g. NTFS</li> </ul>	<b>Remedy</b> <ul style="list-style-type: none"> <li>– Use other USB memory device</li> <li>– Disconnect the PC from the USB-B interface</li> <li>– Reformat the USB memory device to FAT 16 or FAT 32 file system (<u>Caution</u>: Reformatting erases all data on the USB memory device. Back up all data before reformatting.)</li> </ul>
<b>Data transmission to USB printer does not work</b>	<b>Cause</b> <ul style="list-style-type: none"> <li>– The USB-B interface is connected to a PC</li> <li>– Connected USB printer was not recognized</li> </ul>	<b>Remedy</b> <ul style="list-style-type: none"> <li>– Disconnect the PC from the USB-B interface</li> <li>– Use suitable USB printer (see section 12.2 TRANSMITTING DATA TO A USB PRINTER, page 121)</li> <li>– Check the printer settings (see section 12.2 TRANSMITTING DATA TO A USB PRINTER, page 121)</li> </ul>
<b>Error message, <i>Memory error 1</i></b>	<b>Cause</b> <ul style="list-style-type: none"> <li>– Instrument storage was not found</li> </ul>	<b>Remedy</b> <ul style="list-style-type: none"> <li>– <i>Please contact the service.</i></li> </ul>

---

Time gets lost	Cause	Remedy
	– Buffer battery is empty	– Change the buffer battery (see section 13.1.1 GENERAL MAINTENANCE ACTIVITIES, page 126)

## 15 Technical data

### 15.1 Measuring ranges, resolution, accuracy

Measuring ranges, accuracy	Variable	Measuring range	Accuracy
	Air pressure (absolute)*	225 ... 825 mm Hg	± 3 mm Hg

\* Available only if a D.O. sensor is connected



Further data are given in the documentation of your sensor.

### 15.2 General data

Dimensions	Approx. 285 x 255 x 80 mm (11.22 x 10.04 x 3.15 inches)	
Weight	Approx. 2.5 kg (5.51 pounds)	
Mechanical structure	Type of protection	IP 43
Electrical safety	Protective class	III
Test certificates	CE	
Ambient conditions	Storage	- 25 °C ... + 65 °C
	Operation	0 °C ... + 40 °C
	Admissible relative humidity	Yearly mean: < 75 % 30 days/year: 95 % Other days: 85 %
Power supply	Power pack	Helmsman Industrial Co Ltd SEI0901100P Input: 100 ... 240 V ~ / 50 ... 60 Hz / 0.5 A Output: 9 Vdc, 1100 mA
		ShenZhen RiHuiDa Power Supply Co Ltd RHD10W090110 Input: 100 ... 240 V ~ / 50 ... 60 Hz / 0.4 A Output: 9 Vdc, 1100 mA
	Primary plugs	Primary plugs contained in the scope of delivery: Euro, US, UK and Australian.
	Battery (to buffer the system clock in the case of a power failure)	Lithium button cell battery CR 2032, 3 V

USB interface ( <i>USB Device</i> )	Type	USB 1.1 USB-B ( <i>USB Device</i> ), PC
	Baud rate	Adjustable: 1200, 2400, 4800, 9600, 19200 Baud
	Data bits	8
	Stop bits	2
	Parity	None
	Handshake	RTS/CTS
	Cable length	Max. 3 m

USB interface ( <i>USB Host</i> )	Type	USB 2.0 USB-A ( <i>USB Host</i> ), USB device
-----------------------------------	------	--

Guidelines and norms used	EMC	EC directive 2014/30/EC EN 61326-1 EN 61000-3-2 EN 61000-3-3 FCC Class A
	Meter safety	EC directive 2014/35/EC EN 61010-1
	IP protection class	EN 60529



Keypad (antibacterial)

*Client:* **Autotype International Limited****Grove Road  
Wantage  
Oxon  
OX12 7B2  
United Kingdom***Job Ref:* **04I0712***Sample Ref No.:* **LSN 25/71815***Date Received:* **15/07/2004***Date Reported:* **03/03/2005****CERTIFICATE OF ANALYSIS**AUTOTEX AM*Meth. Desc***FILM TEST***Supplier:***AUTOTYPE**

<b>Test</b>	<b>Result</b>	<b>Unit</b>	<b>Est</b>
<b>Salmonella enteritidis</b>	<b>99.6</b>	<b>%</b>	<b>Reduction After 24 Hours</b>
<b>Klebsiella pneumoniae</b>	<b>99.4</b>	<b>%</b>	<b>Reduction After 24 Hours</b>
<b>Pseudomonas aeruginosa</b>	<b>99.1</b>	<b>%</b>	<b>Reduction After 24 Hours</b>
<b>Streptococcus faecalis</b>	<b>99.4</b>	<b>%</b>	<b>Reduction After 24 Hours</b>
<b>Phoma violacea</b>	<b>99.0</b>	<b>%</b>	<b>Reduction After 48 Hours</b>
<b>Penicillium purpurogenum</b>	<b>99.3</b>	<b>%</b>	<b>Reduction After 48 Hours</b>
<b>Bacillus cereus</b>	<b>99.3</b>	<b>%</b>	<b>Reduction After 24 Hours</b>
<b>Sacharmyces cerevisiae</b>	<b>99.3</b>	<b>%</b>	<b>Reduction After 24 Hours</b>

*Comment:* **The microbiological results demonstrate that the material under test exhibits biocidal activity.****R.P.Elliott**  
CChem, MRSC, MIFST  
*Deputy Managing  
Director***C.Fuller**  
BSc. (Hons.), CBiol., MBiol.,  
MIFST*Company Microbiologist***J.Lloyd**  
BSc. (Hons.)*Principal  
Microbiologist***P.M.Sutton**  
CChem., MRSC.*Nutritional Services  
Manager***J.Elliott**  
BSc. (Hons.), CBiol., MBiol*Senior  
Microbiologist***J. Francis**  
BSc. (Hons.)*Senior Microbiologist***N.Stanton**  
BSc. (Hons.)*Senior  
Microbiologist***Law Laboratories Ltd** Shady Lane, Great Barr, Birmingham B44 9ET England

04I0712/6/1/.

*Client:* **Autotype International Limited**  
**Grove Road**  
**Wantage**  
**Oxon**  
**OX12 7B2**  
**United Kingdom**

*Job Ref:* **05B1760**  
*Sample Ref No.:* **LSN 26/38123**  
*Date Received:* **24/10/2004**  
*Date Reported:* **21/02/2005**

# CERTIFICATE OF ANALYSIS

AUTOTEX AM AGED 15 YEARS

*Meth. Desc* **Harmonised JIS Z2801/AATCC 100**

Test	Result	Unit	Est
Staphylococcus aureus	99.0	%	Reduction After 24 Hours
Escherichia coli 0157	99.8	%	Reduction After 24 Hours
Aspergillus niger	99.1	%	Reduction After 48 Hours

*Comment:* **The microbiological results demonstrate that the material under test exhibits biocidal activity against the above listed microbial strains.**



**R.P.Elliott**  
 CChem, MRSC, MIFST  
*Deputy Managing Director*

**C.Fuller**  
 BSc. (Hons.), CBiol., MBiol., MIFST  
*Company Microbiologist*

**J.Lloyd**  
 BSc. (Hons.)  
*Principal Microbiologist*

**P.M.Sutton**  
 CChem., MRSC.  
*Nutritional Services Manager*

**J.Elliott**  
 BSc. (Hons.), CBiol., MBiol  
*Senior Microbiologist*



**J. Francis**  
 BSc. (Hons.)  
*Senior Microbiologist*

**N.Stanton**  
 BSc. (Hons.)  
*Senior Microbiologist*

**Law Laboratories Ltd** Shady Lane, Great Barr, Birmingham B44 9ET England

05B1760/1/3/.

## 16 Firmware update

### 16.1 Firmware update for the meter MultiLab 4010-3W

You can find available firmware update files for your meter on the Internet. With the "Firmware Update " program and a PC you can update the firmware of the MultiLab 4010-3W to the newest version.

For the update you have to connect the meter to a PC.

For the update via the USB-B interface, the following is required:

- a free USB interface (virtual COM port) on the PC
- the driver for the USB interface (on the enclosed CD-ROM)
- the USB cable (included in the scope of delivery of the MultiLab 4010-3W).

1. Install the downloaded firmware update on a PC.  
An update folder is created in the Windows start menu.  
If an update folder already exists for the meter (or meter type), the new data are displayed there.
2. In the windows start menu, open the update folder and start the firmware update program for the meter
3. Using the USB interface cable, connect the MultiLab 4010-3W to a USB interface (virtual COM port) of the PC.
4. Switch on the MultiLab 4010-3W.
5. In the firmware update program, start the update process with OK.
6. Follow the instructions of the firmware update program.  
During the programming process, a corresponding message and a progress bar (in %) are displayed.  
The programming process takes up to 15 minutes. A terminatory message is displayed after a successful programming process. The firmware update is completed.
7. Disconnect the MultiLab 4010-3W from the PC.  
The MultiLab 4010-3W is ready for operation again.

After switching the meter off and on you can check whether the meter has taken over the new software version (see YOU WANT TO KNOW WHICH SOFTWARE VERSION IS IN THE METER OR IDS SENSOR, PAGE 133).

## 16.2 Firmware-Update for IDS Sensors

With the "Firmware Update" program and a PC you can update the firmware of an IDS sensor to the newest version.

You can find available firmware update files for your IDS sensor on the Internet.

For updating, connect the IDS sensor to the MultiLab 4010-3W, and the MultiLab 4010-3W to a PC.

For the update via the USB-B interface, the following is required:

- a free USB interface (virtual COM port) on the PC
- the driver for the USB interface (on the enclosed CD-ROM)
- the USB cable (included in the scope of delivery of the MultiLab 4010-3W).

1. Install the downloaded firmware update on a PC.  
An update folder is created in the Windows start menu.  
If an update folder already exists for the sensor (or sensor type), the new data are displayed there.
2. In the windows start menu, open the update folder and start the firmware update program for the IDS sensor
3. Connect the IDS sensor to the MultiLab 4010-3W meter.
4. Using the USB interface cable, connect the MultiLab 4010-3W to a USB interface (virtual COM port) of the PC.
5. Switch on the MultiLab 4010-3W.
6. In the firmware update program, start the update process with OK.
7. Follow the instructions of the firmware update program.  
During the programming process, a corresponding message and a progress bar (in %) are displayed.  
The programming process takes up to 5 minutes. A terminatory message is displayed after a successful programming process. The firmware update is completed.
8. Disconnect the MultiLab 4010-3W from the PC.  
Meter and sensor are ready for operation again.

After switching the meter off and on you can check whether the sensor has taken over the new software version (see YOU WANT TO KNOW WHICH SOFTWARE VERSION IS IN THE METER OR IDS SENSOR, PAGE 133).

## 17 Glossary

### pH/ORP/ISE

<b>Asymmetry</b>	see zero point
<b>Electromotive force of an electrode</b>	The electromotive force $U$ of the electrode is the measurable electromotive force of an electrode in a solution. It equals the sum of all the galvanic voltages of the electrode. Its dependency on the pH results in the electrode function, which is characterized by the parameters, slope and zero point.
<b>Junction</b>	The junction is a porous body in the housing wall of reference electrodes or electrolyte bridges. It arranges the electrical contact between two solutions and makes the electrolyte exchange more difficult. The expression, junction, is also used for ground or junction-less transitions.
<b>ORP (U)</b>	The ORP is caused by oxidizing or reducing substances dissolved in water if these substances become effective on an electrode surface (e.g. a gold or platinum surface).
<b>pH value</b>	The pH value is a measure of the acidic or basic effect of an aqueous solution. It corresponds to the negative decadic logarithm of the molal hydrogen ions activity divided by the unit of the molality. The practical pH value is the value of a pH measurement.
<b>Potentiometry</b>	Name of a measuring technique. The signal (depending on the measured parameter) of the electrode is the electrical potential. The electrical current remains constant.
<b>Slope</b>	The slope of a linear calibration function.
<b>Zero point</b>	The zero point of a pH electrode is the pH value at which the electromotive force of the pH electrode at a specified temperature is zero. Normally, this is at 25 °C.

### Conductivity

<b>Cell constant (c)</b>	Characteristic quantity of a conductivity measuring cell, depending on the geometry.
<b>Conductivity (<math>\kappa</math>)</b>	Short form of the expression, specific electrical conductivity. It corresponds to the reciprocal value of the resistivity. It is a measured value of the ability of a substance to conduct an electric current. In water analysis, the electrical conductivity is a dimension for the ionized substances in a solution.
<b>Reference temperature</b>	Fixed temperature value to compare temperature-dependent measured values. For conductivity measurements, the measured value is converted to a conductivity value at a reference temperature of 20 °C or 25 °C.
<b>Resistivity (<math>\rho</math>)</b>	Short name for the specific electrolytic resistance. It corresponds to the reciprocal value of the electrical conductivity.

<b>Salinity</b>	The absolute salinity $S_A$ of seawater corresponds to the relationship of the mass of dissolved salts to the mass of the solution (in g/Kg). In practice, this dimension cannot be measured directly. Therefore, the practical salinity according to IOT is used for oceanographic monitoring. It is determined by measuring the electrical conductivity.
<b>Salt content</b>	General designation for the quantity of salt dissolved in water.
<b>Temperature coefficient</b>	Value of the slope $\alpha$ of a linear temperature function. $\mathcal{X}_{T_{Ref}} = \mathcal{X}_{Meas} * \frac{1}{1 + \alpha * (T - T_{Ref})}$
<b>Temperature compensation</b>	Name of a function that considers the temperature influence on the measurement and converts it accordingly. Depending on the measured parameter to be determined, the temperature compensation functions in different ways. For conductimetric measurements, the measured value is converted to a defined reference temperature. For potentiometric measurements, the slope value is adjusted to the temperature of the test sample but the measured value is not converted.

### Dissolved oxygen

<b>D.O. saturation</b>	Short name for the relative D.O. saturation.
<b>Salinity</b>	The absolute salinity $S_A$ of seawater corresponds to the relationship of the mass of dissolved salts to the mass of the solution (in g/Kg). In practice, this dimension cannot be measured directly. Therefore, the practical salinity according to IOT is used for oceanographic monitoring. It is determined by measuring the electrical conductivity.
<b>Salt content</b>	General designation for the quantity of salt dissolved in water.

### General topics

<b>Adjusting</b>	To manipulate a measuring system so that the relevant value (e.g. the displayed value) differs as little as possible from the correct value or a value that is regarded as correct, or that the difference remains within the tolerance.
<b>AutoRange</b>	Name of the automatic selection of the measuring range.
<b>Calibration</b>	Comparing the value from a measuring system (e.g. the displayed value) to the correct value or a value that is regarded as correct. Often, this expression is also used when the measuring system is adjusted at the same time (see adjusting).
<b>Measured parameter</b>	The measured parameter is the physical dimension determined by measuring, e.g. pH, conductivity or D.O. concentration.
<b>Measured value</b>	The measured value is the special value of a measured parameter to be determined. It is given as a combination of the numerical value and unit (e.g. 3 m; 0.5 s; 5.2 A; 373.15 K).

<b>Molality</b>	Molality is the quantity (in Mol) of a dissolved substance in 1000 g solvent.
<b>Reset</b>	Restoring the original condition of all settings of a measuring system.
<b>Resolution</b>	Smallest difference between two measured values that can be displayed by a meter.
<b>Stability control (AutoRead )</b>	Function to control the measured value stability.
<b>Standard solution</b>	The standard solution is a solution where the measured value is known by definition. It is used to calibrate a measuring system.
<b>Temperature function</b>	Name of a mathematical function expressing the temperature behavior of a test sample, a sensor or part of a sensor.
<b>Test sample</b>	Designation of the test sample ready to be measured. Normally, a test sample is made by processing the original sample. The test sample and original sample are identical if the test sample was not processed.





## 18 Index

### A

AutoRead .....	69, 90
ORP .....	42, 44
pH .....	25, 47

### B

Battery compartment .....	126
Blank value addition .....	66

### C

Calibration	
Conductivity .....	93
ISE .....	50
pH .....	27, 45
Calibration evaluation	
Conductivity .....	95
ISE .....	55
O2 .....	78
pH .....	36
Calibration interval	
Conductivity .....	107
O2 .....	104
pH .....	101
Calibration points	
pH .....	34
Cell constant .....	93
Comparison measurement (D.O.) .....	73
Connect the power pack .....	13
Connecting a PC .....	120, 123
Connectors .....	16

### D

Data storage	
Automatic .....	114
Dataset .....	118
Date and time .....	23
Default settings	
Measured parameter .....	111
System settings .....	113
Display .....	15

### F

FDO® Check .....	71
Firmware update .....	139

### I

Initial commissioning .....	12
Initialize .....	111
Interval for calibration .....	101

### K

Keys .....	14
------------	----

### M

Measured value display .....	19
Measurement accuracy .....	101
Measurement dataset .....	118
Measurement datastorage	
Storage locations .....	119
Measuring	
Conductivity .....	89
ISE .....	46
O2 .....	68
ORP .....	42, 44
pH .....	25
Measuring method .....	56
Blank value addition .....	66
Sample addition .....	61
Sample subtraction .....	63
Standard addition .....	57
Standard subtraction .....	59
Menu for calibration and measurement settings	
pH/ORP .....	102
Menus (navigation) .....	20
Messages .....	21

### P

pH buffer sets .....	99
----------------------	----

### R

Reset .....	111
-------------	-----

### S

Safety .....	10
Sample addition .....	61
Sample subtraction .....	63
Scope of delivery .....	12
Single-point calibration	
pH .....	29, 33
Slope	
ISE .....	50
pH .....	27
Stability control	
Automatic .....	110
Manual .....	25, 42, 69
Standard addition .....	57
Standard addition with blank value correction	
66	
Standard subtraction .....	59

---

Storage .....	114
Manual .....	114
Storing interval .....	114

**T**

Temperature compensation .....	91
Temperature measurement	
Conductivity .....	91
ISE .....	48
O2 .....	70
pH .....	27, 45
Three-point calibration	
ISE .....	53
pH .....	30, 34
Transmitting data .....	120
Transmitting measured values .....	120
Two-point calibration	
ISE .....	52
pH .....	29, 33

**Z**

Zero point of pH electrode .....	27
----------------------------------	----

## 19 Appendix

### 19.1 Oxygen solubility table

Solubility of oxygen that is exposed to water-saturated air at a pressure of 760 mm Hg.

Salt content = Measured value of the quantity of salts dissolved in water.

Chlorine content = Measured value of the chlorine content, according to weight, of water.

$S(0/00) = 1.80655 \times \text{chlorine content } (0/00)$

Temp °C	Chlorine content: 0 Salt content: 0	5.0 ppt 9.0 ppt	10.0 ppt 18.1 ppt	15.0 ppt 27.1 ppt	20.0 ppt 36.1 ppt	25.0 ppt 45.2 ppt
0.0	14.621	13.728	12.888	12.097	11.355	10.657
1.0	14.216	13.356	12.545	11.783	11.066	10.392
2.0	13.829	13.000	12.218	11.483	10.790	10.139
3.0	13.460	12.660	11.906	11.195	10.526	9.897
4.0	13.107	12.335	11.607	10.920	10.273	9.664
5.0	12.770	12.024	11.320	10.656	10.031	9.441
6.0	12.447	11.727	11.046	10.404	9.799	9.228
7.0	12.139	11.442	10.783	10.162	9.576	9.023
8.0	11.843	11.169	10.531	9.930	9.362	8.826
9.0	11.559	10.907	10.290	9.707	9.156	8.636
10.0	11.288	10.656	10.058	9.493	8.959	8.454
11.0	10.027	10.415	9.835	9.287	8.769	8.279
12.0	10.777	10.183	9.621	9.089	8.586	8.111
13.0	10.537	9.961	9.416	8.899	8.411	7.949
14.0	10.306	9.747	9.218	8.716	8.242	7.792
15.0	10.084	9.541	9.027	8.540	8.079	7.642
16.0	9.870	9.344	8.844	8.370	7.922	7.496
17.0	9.665	9.153	8.667	8.207	7.770	7.356
18.0	9.467	8.969	8.497	8.049	7.624	7.221
19.0	9.276	8.792	8.333	7.896	7.483	7.090
20.0	9.092	8.621	8.174	7.749	7.346	6.964
21.0	8.915	8.456	8.021	7.607	7.214	6.842
22.0	8.743	8.297	7.873	7.470	7.087	6.723
23.0	8.578	8.143	7.730	7.337	6.963	6.609
24.0	8.418	7.994	7.591	7.208	6.844	6.498
25.0	8.263	7.850	7.457	7.093	6.728	6.390
26.0	8.113	7.711	7.327	6.962	6.615	6.285
27.0	7.968	7.575	7.201	6.845	6.506	6.184
28.0	7.827	7.444	7.079	6.731	6.400	6.085
29.0	7.691	7.317	6.961	6.621	6.297	5.990
30.0	7.559	7.194	6.845	6.513	6.197	5.896
31.0	7.430	7.073	6.733	6.409	6.100	5.806

---

Temp °C	Chlorine content: 0 Salt content: 0	5.0 ppt 9.0 ppt	10.0 ppt 18.1 ppt	15.0 ppt 27.1 ppt	20.0 ppt 36.1 ppt	25.0 ppt 45.2 ppt
32.0	7.305	6.957	6.624	6.307	6.005	5.717
33.0	7.183	6.843	6.518	6.208	5.912	5.631
34.0	7.065	6.732	6.415	6.111	5.822	5.546
35.0	6.950	6.624	6.314	6.017	5.734	5.464
36.0	6.837	6.519	6.215	5.925	5.648	5.384
37.0	6.727	6.416	6.119	5.835	5.564	5.305
38.0	6.620	6.316	6.025	5.747	5.481	5.228
39.0	6.515	6.217	5.932	5.660	5.400	5.152
40.0	6.412	6.121	5.842	5.576	5.321	5.078
41.0	6.312	6.026	5.753	5.493	5.243	5.005
42.0	6.213	5.934	5.667	5.411	5.167	4.993
43.0	6.116	5.843	5.581	5.331	5.091	4.861
44.0	6.021	5.753	5.497	5.252	5.017	4.793
45.0	5.927	5.665	5.414	5.174	4.944	4.724
46.0	5.835	5.578	5.333	5.097	4.872	4.656
47.0	5.744	5.493	5.252	5.021	4.801	4.589
48.0	5.654	5.408	5.172	4.947	4.730	4.523
49.0	5.565	5.324	5.094	4.872	4.660	4.457
50.0	5.477	5.242	5.016	4.799	4.591	4.392

## 19.2 Calibration values for different barometric pressures and heights

Pressure				Height		Calibration values
Inches Hg	mm Hg	kPa	mbar	Foot	Meters	% Saturation
30.22	767.6	102.3	1023	-276	-84	101
29.92	760	101.3	1013	0	0	100
29.62	752.4	100.3	1003	278	85	99
29.32	744.8	99.3	993	558	170	98
29.02	737.2	98.3	983	841	256	97
28.72	729.6	97.3	973	1126	343	96
28.43	722	96.3	963	1413	431	95
28.13	714.4	95.2	952	1703	519	94
27.83	706.8	94.2	942	1995	608	93
27.53	699.2	93.2	932	2290	698	92
27.23	691.6	92.2	922	2587	789	91
26.93	684	91.2	912	2887	880	90
26.63	676.4	90.2	902	3190	972	89
26.33	668.8	89.2	892	3496	1066	88
26.03	661.2	88.1	881	3804	1106	87
25.73	653.6	87.2	871	4115	1254	86
25.43	646	86.1	861	4430	1350	85
25.13	638.4	85.1	851	4747	1447	84
24.84	630.8	84.1	841	5067	1544	83
24.54	623.2	83.1	831	5391	1643	82
24.24	615.6	82.1	821	5717	1743	81
23.94	608.0	81.06	811	6047	1843	80
23.64	600.4	80.05	800	6381	1945	79
23.34	592.8	79.03	790	6717	2047	78
23.04	585.2	78.02	780	7058	2151	77
22.74	577.6	77.01	770	7401	2256	76
22.44	570.0	75.99	760	7749	2362	75
22.14	562.4	74.98	749	8100	2469	74
21.84	554.8	73.97	739	8455	2577	73
21.54	547.2	72.95	729	8815	2687	72
21.26	539.6	71.94	720	9178	2797	71
20.94	532	70.93	709	9545	2909	70
20.64	524	69.92	699	9917	3023	69
20.35	517	68.91	689	10293	3137	68
20.05	509	67.9	679	10673	3371	67
19.75	502	66.89	669	11058	3371	66

### 19.3 Calculate the TDS Multiplier

The TDS constant is a multiplier used to calculate an estimated Total Dissolved Solids (TDS) value from conductivity. The multiplier is used to convert specific conductance in mS/cm to TDS in g/L. The default value is 0.65. Enter a new value between 0 and 0.99.

This multiplier is highly dependent on the nature of the ionic species present in the water sample. To be assured of moderate accuracy for the conversion, you must determine a multiplier for the water at your sampling site. Use the following procedure to determine the multiplier for a specific sample:

1. Determine the specific conductance of a water sample from the site.
2. Filter a portion of water from the site.
3. Carefully measure a volume of the filtered water. Completely evaporate to yield a dry solid.
4. Accurately weight the remaining solid.
5. Divide the weight of the solid (in grams) by the volume of water used (in liters) to yield the TDS value in g/L for the site.
6. Divide the TDS value in g/L by the specific conductance of the water in mS/cm to yield the conversion multiplier.



Make sure to use the correct units.



If the nature of the ionic species at the site changes between sampling studies, the TDS values will be in error. TDS cannot be calculated accurately from specific conductance unless the make-up of the chemical species in the water remains constant.

## 20 Contact Information

### 20.1 Ordering & Technical Support

Telephone: (800) 897-4151  
(937) 767-7241  
Monday through Friday, 8:00 AM to 5:00 PM ET

Fax: (937) 767-1058

Email: [info@ysi.com](mailto:info@ysi.com)

Mail: YSI Incorporated  
1725 Brannum Lane  
Yellow Springs, OH 45387  
USA

Internet: [www.ysi.com](http://www.ysi.com)

When placing an order please have the following information available:

- YSI account number (if available)
- Model number or brief description
- Quantity
- Name and Phone Number
- Billing and shipping address
- Purchase Order or Credit Card

### 20.2 Service Information

YSI has authorized service centers throughout the United States and Internationally. For the nearest service center information, please visit [www.ysi.com](http://www.ysi.com) and click 'Support' or contact YSI Technical Support directly at 800-897-4151.

When returning a product for service, include the Product Return form with cleaning certification. The form must be completely filled out for an YSI Service Center to accept the instrument for service. The Product Return form may be downloaded at [www.ysi.com](http://www.ysi.com) and clicking on the 'Support' tab.







# Xylem ['zīləm]

- 1) The tissue in plants that brings water upward from the roots;
- 2) a leading global water technology company.

We're 12,500 people unified in a common purpose: creating innovative solutions to meet our world's water needs. Developing new technologies that will improve the way water is used, conserved, and re-used in the future is central to our work. We move, treat, analyze, and return water to the environment, and we help people use water efficiently, in their homes, buildings, factories and farms. In more than 150 countries, we have strong, long-standing relationships with customers who know us for our powerful combination of leading product brands and applications expertise, backed by a legacy of innovation.

**For more information on how Xylem can help you, go to [www.xylem.com](http://www.xylem.com)**



a **xylem** brand

YSI  
1725 Brannum Lane  
Yellow Springs, OH 45387  
Tel: +1 937-767-7241; 800-765-4974  
Fax: +1 937-767-1058  
Email: [info@ysi.com](mailto:info@ysi.com)  
Web: [www.ysi.com](http://www.ysi.com)

©Xylem Inc